

DISCHARGING

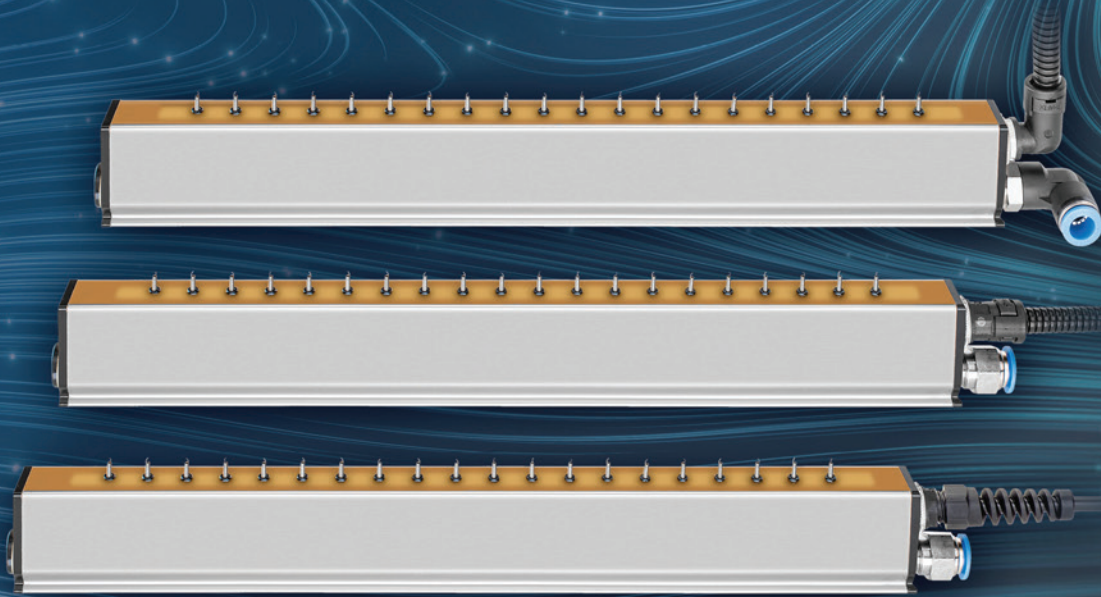

eltex

electrostatic
innovations



flexBAR R60L

HIGH-END discharge for ultimate discharge performance

The flexBAR R60L with freestanding, air-supported spring tips offers a very high passive discharge efficiency, allowing active operation even at low level of AC high voltage. A small amount of air can be blown through the hollow spring tip to increase the range.

Advantages at a glance

- › excellent discharge performance at close and wide range
- › variable use in tight, grounded machine spaces
- › high discharge performance due to patented spring tip
- › reduced dirt adhesion due to optional air circulation around the spring tips
- › no health hazards in case of electric shocks when touching individual tips (≤ 10 tips)

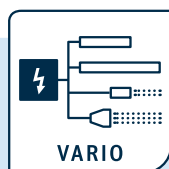

VARIO

Suitable for connecting
one or more Eltex
discharge components:



PRO IONIZER ES61



BASE IONIZER ES60



COMPACT IONIZER ES24



flexBAR R60L

Technical Information

Bar element	aluminum with special coating	
Encapsulation material	polyurethane, UL-94 V-0	
Emission tips	stainless steel, flexible	
Installation material	glas fiber reinforced plastic bracket	
Operating ambient temperature.	0 ... +80 °C	
Ambient humidity	max. 70 % RH, non-dewing	
Available active lengths	15 – 2715 mm in 30 mm steps	
Dimensions	20 x 45 mm, max. length: 2785 mm	
Weight	approx. 1,6 kg/m	
Operating voltage	max. 5 kV AC	
High voltage connection	axial or radial (300° rotatable)	
Short circuit current/tip	max. 0,046 mA	
Contact protection	according to EN 61140	
Compressed air		
Air connection	quick plug coupling NW10	
	maximum Pressure	Air consumption per meter
	max. 3 x 10 ⁵ Pa: AL ≤ 375	0,1 bar single-sided 1,1 Nm ³ /h
	max. 4 x 10 ⁵ Pa: 405 < AL ≤ 705	0,2 bar single-sided 2,2 Nm ³ /h
	max. 5 x 10 ⁵ Pa: 735 < AL ≤ 975	0,1 bar double-sided 1,95 Nm ³ /h
	max. 6 x 10 ⁵ Pa: AL > 1005	0,2 bar double-sided 3,8 Nm ³ /h
Following Standards are fulfilled	ANSI-ESD-STM3.1, RCJS-TR-5-4, JIS C 61340-4-7, IEC 61340-4-7 ED.2 Ionbalance*	

* In connection with the PRO IONIZER ES61 power supply and defined parameters

Mounting options

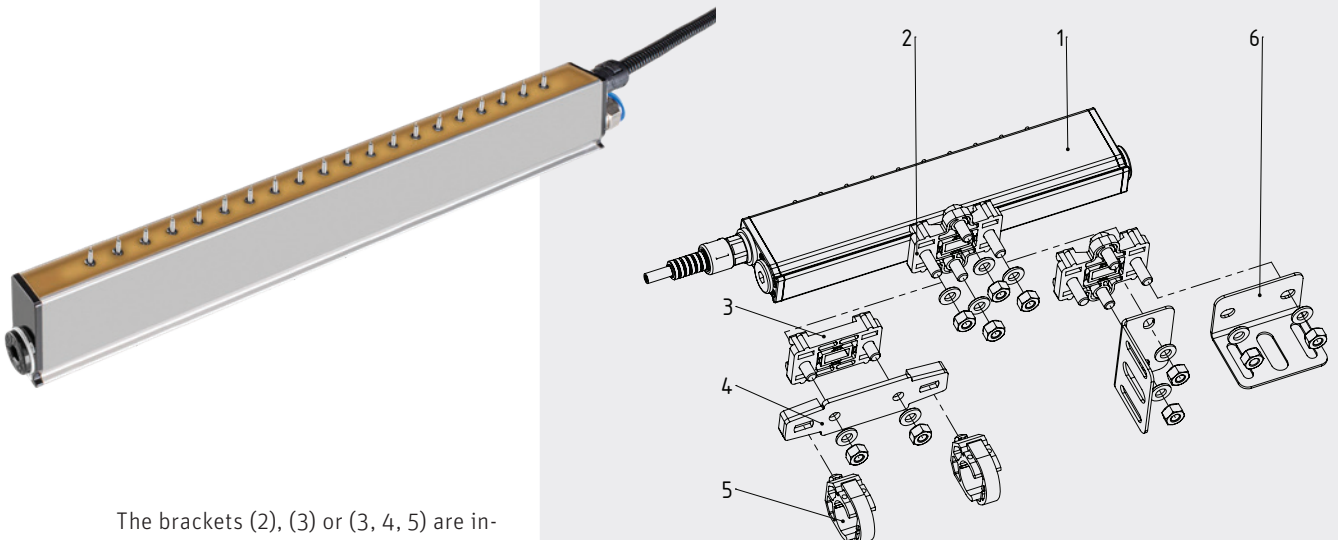

The brackets (2), (3) or (3, 4, 5) are included in the standard scope of delivery depending on the configuration. The brackets (6) can be ordered separately.



flexBAR R60L

Dimensions

Attachment clips

Scope of delivery related to total length

up to 1 m: 2 pieces / bar

up to 2 m: 3 pieces / bar

up to 3 m: 4 pieces / bar

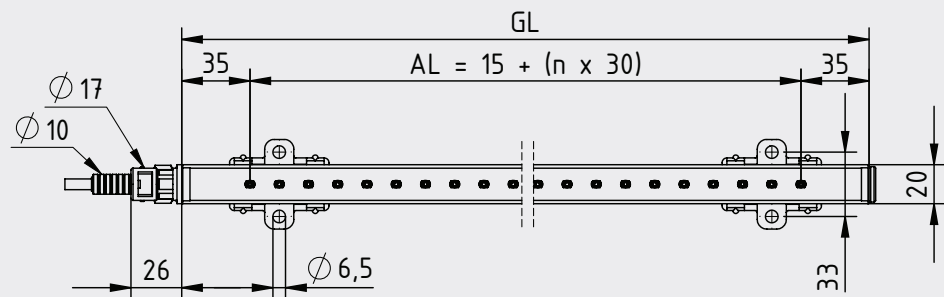
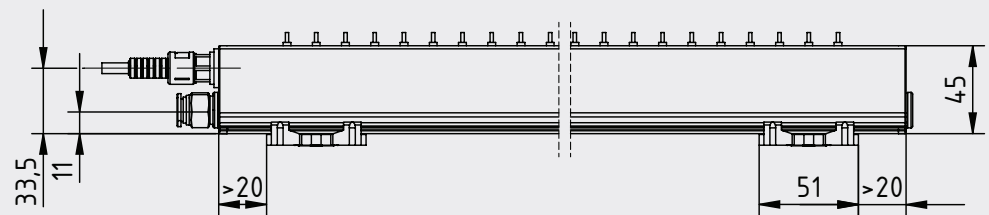
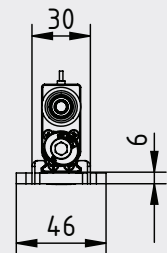

GL = total length

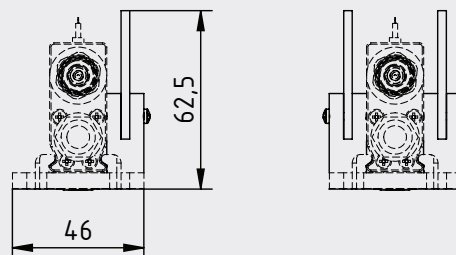
**Protection profile** (optional)Protective strip on one or both sides
to protect the spring tip