

Operating Instructions

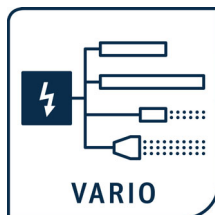

F01095Y



PRO IONIZER

Series ES61 Power Supply for AC operation

BA-en-2089-2408



How-To-Do Video: **Ion balance**

Setting the ion balance with the ELTEX PRO IONIZER

URL: www.youtube.com/watch?v=nfK2tIDWc4Q



How-To-Do Video: **Performance Control**

Calibration, Performance Control and Pollution monitoring

URL: www.youtube.com/watch?v=6UKzQX_HFcQ



ES61 in detail

URL: <https://www.eltex.de/en/pro-ionizer>



List of contents

1	Outline of appliance	7
1.1	Outline of appliance ES61 power supply with display	7
1.2	Outline of appliance ES61 power supply with membrane keyboard	8
1.3	Outline of appliance ES61/e power supply for connecting Ex discharging bars with display or membrane keypad	9
1.4	Variants	10
2	Safety	11
2.1	Identification of risks and hazards	11
2.2	Contact protection	11
2.3	Proper use	11
2.4	Work and operational safety	12
2.5	Technical advance	14
3	Installation and assembly	15
3.1	Assembly the power supply	15
3.2	Ground connection	16
3.3	Discharging bars, ion blower nozzles / heads, ion blower pistols and distributors suitable for connection	17
3.3.1	Maximum active bar length and length of the high voltage cable	17
3.3.2	Connecting the high voltage cable	19
3.3.3	Disconnecting the high voltage cable	20
3.4	Connecting the supply voltage	20
3.4.1	Connecting the supply voltage DC (ES61/_D)	20
3.4.2	Connecting the supply voltage AC (ES61/_A)	21
3.4.3	External protection	21
3.5	Sensor input (optional)	22
3.6	I/O Interface (optional)	23
3.7	Field bus Interfaces	24
3.7.1	CANopen® (optional)	25
3.7.2	ModbusTCP (optional)	26
3.8	Use of the Eltex signal cable CS and mains cable KN	27
4	Operation	29
4.1	Startup	29
4.2	Setting the power supply ES61	29
4.3	Function monitoring	31
4.4	Releasing the high voltage	37
4.5	Integrated control elements	38
4.5.1	Using the membrane keyboard	38
4.5.1.1	Description of the buttons	39
4.5.1.2	Switching the bar display	39
4.5.1.3	Setting the setpoint Discharge voltage	39

4.5.1.4	Setting the frequency Discharge voltage	40
4.5.1.5	Setting the ion balance	40
4.5.1.6	Setting and deleting the software release	41
4.5.1.7	Saving the parameters	41
4.5.1.8	Loading the factory settings	41
4.5.1.9	Acknowledge error or warning messages	41
4.5.1.10	Setup menu Device settings	41
4.5.1.10.1	Start Setup menu	43
4.5.1.10.2	Option Software release	43
4.5.1.10.3	Option Hardware release	44
4.5.1.10.4	Signal output mode	45
4.5.1.10.5	Sensor input mode	46
4.5.1.10.6	CANopen® Node address	47
4.5.1.10.7	CANopen® Baud rate	48
4.5.1.10.8	Setup Exit	48
4.5.1.11	Setup menu Performance Control	49
4.5.1.11.1	Start Setup menu	50
4.5.1.11.2	Activation reference point	51
4.5.1.11.3	Pollution monitoring connection	52
4.5.1.11.4	Active length of the device	53
4.5.1.11.5	Cable length	54
4.5.1.11.6	Setup Exit	54
4.5.2	Using the display	55
4.5.2.1	Release	56
4.5.2.2	Configuration	56
4.5.2.2.1	ECC User	57
4.5.2.2.2	Access Management	58
4.5.2.2.3	Settings	59
4.5.2.2.4	Highlight Values	60
4.5.2.2.5	Factory Settings	60
4.5.2.2.6	Login	60
4.5.2.3	Preset	61
4.5.2.4	Message overview	62
4.5.2.5	Parameters	63
4.5.2.5.1	Discharge Parameters	65
4.5.2.5.2	Performance Control Parameters	66
4.5.2.5.3	General Parameters	67
4.5.2.5.4	Sensor Parameters	68
4.5.2.6	Actual values	71
4.5.2.6.1	Actual values Discharge	71
4.5.2.6.2	Actual values Performance Control	72
4.5.2.6.3	Actual values General	73
4.5.2.6.4	Actual values Sensor	74
4.5.2.7	General Device Information	75

5	Maintenance	76
6	Trouble-shooting	77
6.1	Error messages	77
6.2	Warning messages	83
7	Technical specifications ES61	87
8	Dimensions	89
9	Spare parts and accessories	90
10	Waste disposal	91
A	ANNEX.	92
A.1	Assembly of the plugs	92
A.1.1	Plug M16 for 24 V DC supply voltage straight version, version with shield clamping ring	92
A.1.2	Plug M12, 4 or 5-pin for I/O interface and sensor input	93
A.2	Overview of the actual values	92
A.2.1	Actual values Discharge	94
A.2.2	Actual values Performance Control	95
A.2.3	Actual values General.	95
A.2.4	Actual values Sensor	96
A.3	Overview Parameters.	97
A.3.1	Parameters Discharge	97
A.3.2	Parameters Performance Control.	98
A.3.3	Parameters General	100
A.3.4	Parameters Sensor.	101
A.4	Optimisation of the residual charge	104
A.5	Pollution monitoring	106
	Declaration of Conformity	108
	UKCA Conformity	109

Dear Customer,

The PRO IONIZER ES61 high voltage power supply is an universal power supply unit for controlled discharging.

The ES61 power supply units may only be operated with the associated Eltex discharging bars for AC operation and the ion blower nozzles, the ion blower pistols and distributors, each with a permanently connected high-voltage cable.

A variety of Eltex discharging bars for AC operation as well as ion blower nozzles, ion blower pistols and distributors, each with a permanently connected high-voltage cable, are available.

The discharging bars and the ES61 power supply are used mainly in cases where disruptive static charges impair production processes and need to be eliminated.

The ES61 power supply is characterized by the following features::

- 4 plug-type high voltage outputs
- stable output voltage adjustable between 3.5 - 5 kV AC
- easy adjustment of the ion balance and the discharge frequency between 50 Hz and 200 Hz
- small dimensions
- easy installation
- solid design in protection class IP54
- robust, compact design
- low weight
- integrated function and error monitoring
- LED display for visualization the operating status
- Integration of the power supply in CANopen® networks (optional)
- Industrial Ethernet support (optional)
- Sensor input (optional)
- Operation of Ex discharging bars (optional)

The language setting for the display variant can be found in [chapter 4.5.2.2.3 "Settings", page 59](#).

Please read the operating instructions carefully before starting the appliance. This will help you prevent personal injuries and damage to property.

Please give us a call if you have any suggestions, proposals or ideas for improvements. We greatly appreciate the feedback from the users of our appliances.

1. Outline of appliance ES61 power supply

1.1 Outline of appliance ES61 power supply with display

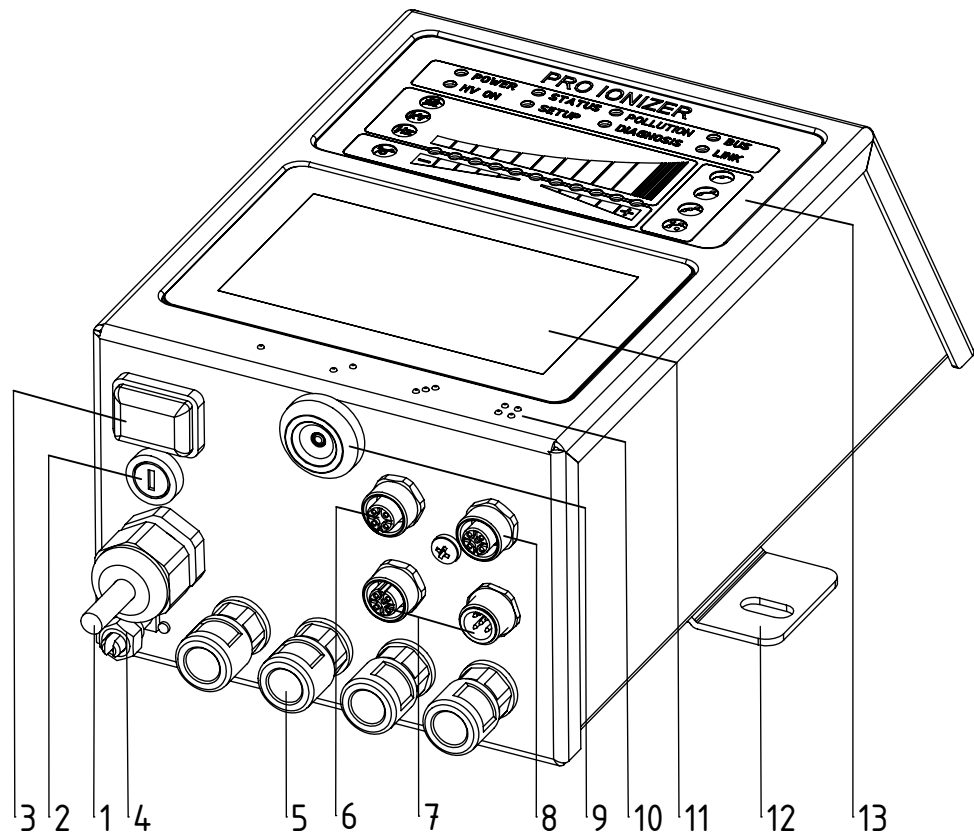

Fig. 1:
ES61 high voltage
power supply
with display

- 1 Power supply lead
- 2 Fuse (type: see name plate)
- 3 Operating switch ON / OFF
- 4 Ground terminal
- 5 High voltage connections (4 pieces)
- 6 Sensor input (optional)
- 7 Interface 1 and 2 field bus (optional)
- 8 I/O interface (optional)
- 9 Service interface
- 10 Marking high voltage connections (1 to 4)
- 11 Touch screen
- 12 Mounting bracket
- 13 Illuminated displays

Z-118404cy_1

1.2 Outline of appliance ES61 power supply with membrane keyboard

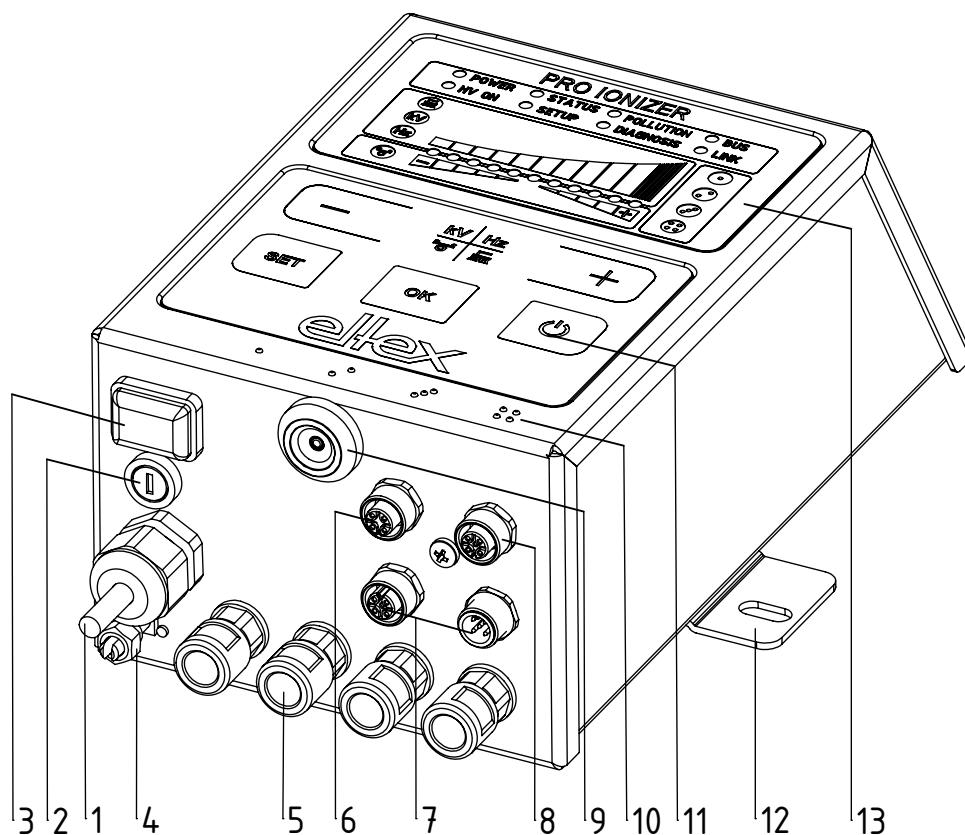

Fig. 2:
ES61 high voltage
power supply
with membrane
keyboard

- 1 Power supply lead
- 2 Fuse (type: see name plate)
- 3 Operating switch ON / OFF
- 4 Ground terminal
- 5 High voltage connections (4 pieces)
- 6 Sensor input (optional)
- 7 Interface 1 and 2 field bus (optional)
- 8 I/O interface (optional)
- 9 Service interface
- 10 Marking high voltage connections (1 to 4)
- 11 Keyboard
- 12 Mounting bracket
- 13 Illuminated displays

Z-118404cy_2

1.3 Outline of appliance ES61/E power supply for connecting Ex discharging bars with display or membrane keypad



Abb. 3:
ES61/E high voltage power supply-
shown here with
membrane keypad

- 1 Power supply lead
- 2 Fuse (type: see name plate)
- 3 Operating switch ON / OFF
- 4 Ground terminal
- 5 High voltage connections (4 pieces)
- 6 Sensor input (optional)
- 7 Interface 1 and 2 field bus (optional)
- 8 I/O interface (optional)
- 9 Service interface
- 10 Marking high voltage connections (1 to 4)
- 11 Keyboard
- 12 Mounting bracket
- 13 Illuminated displays

Z-118404cy_11

2. Safety

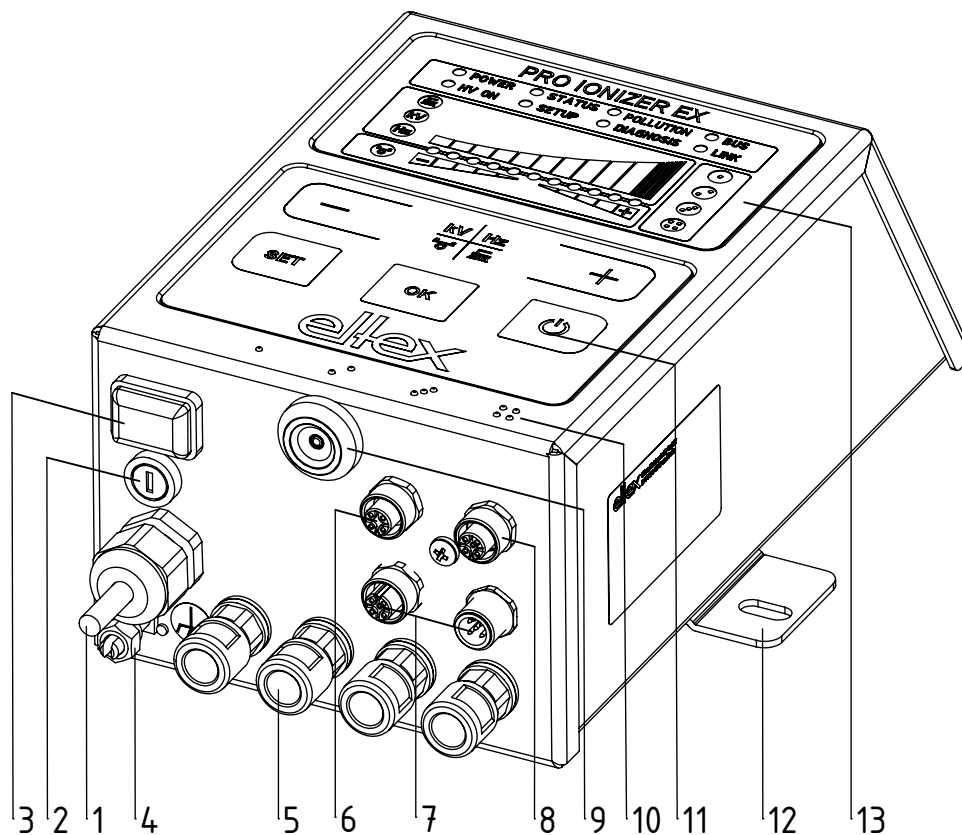
The ES61 units have been designed, built and tested using state-of-the-art engineering, and have left the factory in perfect technic and safety condition. Nevertheless, the appliance can pose a risk to persons and property if it is operated improperly. Read the operating instructions carefully and observe the safety instructions.

For warranty conditions, please refer to the General Terms and Conditions (GTC), see www.eltex.de.

2.1 Identification of risks and hazards

The following symbols are used in the operating instructions to indicate possible risks and hazards when using the power supply units:



Warning!

This symbol appearing in the operating instructions refers to operations which, if carried out improperly, may result in serious personal injuries.



Caution!

This symbol appearing in the operating instructions refers to operations which, if carried out improperly, may pose a danger to property.

2.2 Contact protection

The site of installation and/or use of the units is outside the control of Eltex, contact protection against inadvertent contact of the bars and of live components by personnel as specified by the employer's liability insurance association may have to be provided (e.g. DGUV V3 in Germany). Contact protection devices made of conductive material must be grounded.

2.3 Proper use

The ES61 power supplies may be operated only in connection with the appropriate Eltex discharging bars for AC operation as well as the ion blower nozzles, ion blower pistols and distributors, each with a permanently connected high voltage cable.

Modifications or changes made to the power supplies are not permitted.

Only original Eltex spare parts and accessories may be used.

The manufacturers will not assume any liability and warranty if the units are used improperly or used outside the intended purpose.

2.4 Work and operational safety



Warning!

Carefully observe the following notes and the complete [chapter 2 "Safety", page 11!](#)

Always observe the rules and regulations applying in your country with reference to electrical appliances.

- Before installation, rectifying malfunctions and before carrying out cleaning or maintenance work on the devices and the associated components, switch off the power supply and disconnect the mains supply (see [chapter 3 "Installation and assembly", page 15](#), [chapter 5 "Maintenance", page 76](#), [chapter 6 "Trouble-shooting", page 77](#)).
- If electrically conductive substrates or substrates coated with conductive material (e.g. metal foil or metal composites) are processed, the release of the high voltage must be disabled (see [chapter 3.8 "Use of the Eltex signal cable CS and mains cable KN", page 27](#), [chapter 4.4 "Releasing the high voltage", page 37](#)).
- Before carrying out any work involving the units, the machine which has the units fitted must not be in operation (see [chapter 3 "Installation and assembly", page 15](#), [chapter 5 "Maintenance", page 76](#), [chapter 6 "Trouble-shooting", page 77](#)).
- Any work involving the units must be carried out by qualified electricians (see [chapter 3 "Installation and assembly", page 15](#), [chapter 5 "Maintenance", page 76](#), [chapter 6 "Trouble-shooting", page 77](#), [chapter 10 "Waste disposal", page 91](#)).
- The site of installation must be dry and as dust-free as possible and the air circulation must not be impaired (see [chapter 3.1 "Assembly the power supply", page 15](#)).
- A permanent grounding connection must be made and checked via the ground terminal before the startup of the power supply. The ground cable should have a minimum cross section of 1.5 mm² and should be routed with the shortest possible distance to the machine frame. If the length of the cable is > 0.5 m, the cross section must be at least 2.5 mm². The ground connection must be permanently ensured for the entire operating time of the power supply (see [chapter 3.2 "Ground connection", page 16](#)).
- When routing the high voltage cables, observe [chapter 3.3.2 "Connecting the high voltage cable", page 19](#).
- For applications involving moving bars, the high voltage cable must be attached such that there is no cable movement near the connection zone of the power supply unit (see [chapter 3.3 "Discharging bars, ion blower nozzles / heads, ion blower pistols and distributors suitable for connection", page 17](#), [chapter 3.3.2 "Connecting the high voltage cable", page 19](#)).

- If no discharging bar is connected to the respective plug connection of the power supply, the connection must be closed with the supplied blind plug (see [chapter 3.3 "Discharging bars, ion blower nozzles / heads, ion blower pistols and distributors suitable for connection", page 17](#), [chapter 3.3.2 "Connecting the high voltage cable", page 19](#)).
- Observe the maximum total active bar length and length of the high voltage cable (see [chapter 3.3.2 "Connecting the high voltage cable", page 19](#)).
- Disconnect and/or connect the bars only when the power supply is switched off (see [chapter 3.3.2 "Connecting the high voltage cable", page 19](#)).
- To ensure that no voltage is supplied to the bars when the material web is at rest, enabling the supply voltage to the power supply via machine contact is recommended. If the material web is at rest, or if the machine is not in operation, no high voltage is supplied to the bars in this case (see [chapter 3.4 "Connecting the supply voltage", page 20](#)).
- Due to the power consumption of the high voltage power supply, the cable cross-sections should be as large and the cables as short as possible in order to reduce cable loss (see [chapter 3.4.1 "Connecting the supply voltage DC \(ES61/ _D\)", page 20](#)).
- The voltage at the individual contacts must not exceed 60 V DC (see [chapter 3.4.1 "Connecting the supply voltage DC \(ES61/ _D\)", page 20](#), [chapter 3.5 "Sensor input \(optional\)", page 22](#), [chapter 3.7 "Field bus Interfaces", page 24](#)).
- Please ensure that the signal lines are connected correctly to avoid damaging the power supply unit (see [chapter 3.5 "Sensor input \(optional\)", page 22](#)).
- When using the variant with CANopen®, a cable suitable for CAN bus networks with a surge resistance of 120 ohms must be used for both bus leads (see [chapter 3.7.1 "CANopen® \(optional\)", page 25](#)).
- Shielded cables must always be used for the interface cables; the shields must be connected at both ends (see [chapter 3.5 "Sensor input \(optional\)", page 22](#), [chapter 3.6 "I/O interface \(optional\)", page 23](#), [chapter 3.7.2 "ModbusTCP \(optional\)", page 26](#)).
- When using the CS signal cable and the KN mains cable optionally available from Eltex, the colored markings and the bending radii must be observed when connecting the individual leads (see [chapter 3.8 "Use of the Eltex signal cable CS and mains cable KN", page 27](#)).
- Check the power supply, all connected units, the electrical wiring and the high voltage cables at regular intervals for any damage. If there is any damage, it must be repaired before further operation of the appliances or the appliances must be taken out of service.

- It is not intended to open the device or remove the housing cover. The protection class IP54 only applies if the housing cover is closed and the cable connections are shrouded.
- Before commissioning, the user must ensure that the power supply unit and the discharging bars have been installed and fitted correctly. The supply voltage can then be switched on (see [chapter 4.1 "Startup", page 29](#)).
- The power supply must be checked regularly to ensure its proper functioning. The connection area of the high voltage cables must be free of dirt (see [chapter 5 "Maintenance", page 76](#)).

2.5 Technical advance

The manufacturer reserves the right to make changes to the technical specifications without prior notice in order to adapt the units to state-of-the-art engineering. Eltex will be happy to provide you the latest information on any changes or modifications in the operating instructions on request.

3. Installation and assembly

3.1 Assembly the power supply

The unit is prepared for wall mounting. It is attached using the mounting brackets. When mounting the unit, make sure that the operating elements and the connector terminals remain easily accessible and that the unit can be checked.



The site of installation must be dry and as dust-free as possible and the air circulation must not be impaired.

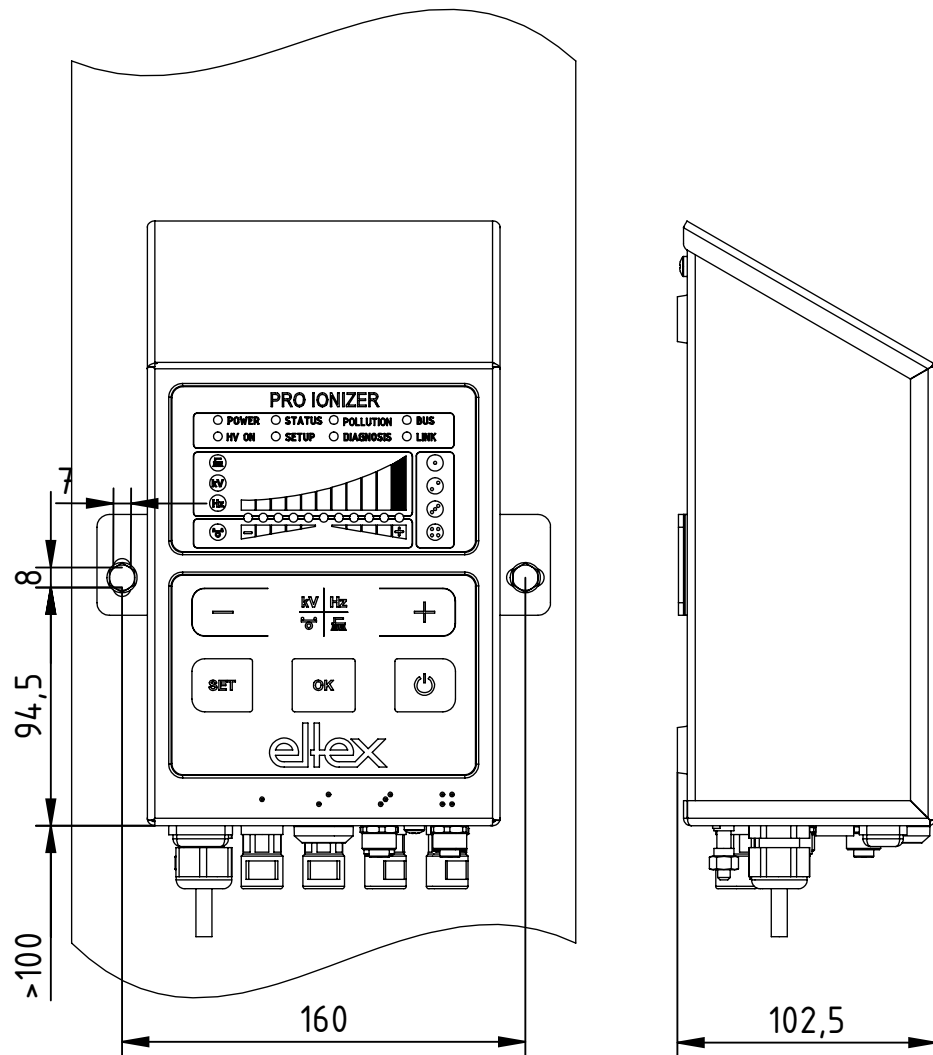

Fig. 4:
Installation of the
power supply,
vertical installation

Z-118404y_4

Mounting position

Fig. 4 and Fig. 5 show the two permitted mounting positions. It must be ensured that the permissible ambient temperature is not exceeded on any side of the housing and at any time.

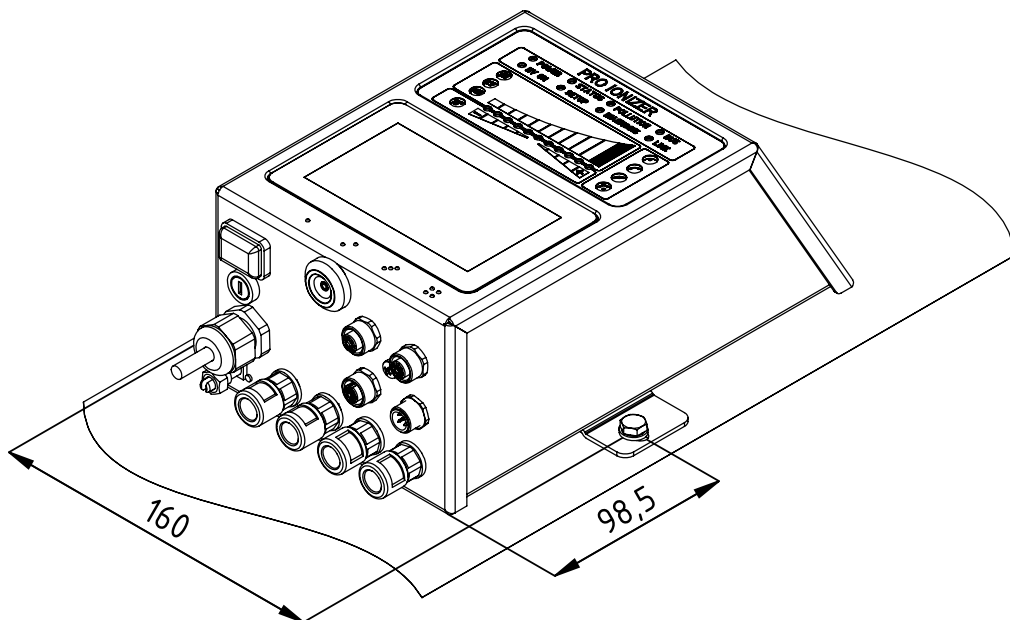

Fig. 5:
Installation of the
power supply,
horizontal
installation

Z-118404cy_5

3.2 Ground connection



A functioning ground connection must be ensured during the entire service life of the power supply. The ground cable should have a minimum cross section of 1.5 mm^2 and should be routed with the shortest possible distance to the machine frame. A cross section of 2.5 mm^2 is required for cable lengths exceeding 0.5 meters. Eltex recommends using the ground cable supplied with the power supply.

Ground terminal

Insert the ground cable into the side slot of the open terminal until it protrudes on the opposite side. Then tighten the integrated safety screw of the terminal as far as it will go (5 Nm).

3.3 Discharging bars, ion blower nozzles / heads, ion blower pistols and distributors suitable for connection

Only Eltex discharging bars for AC operation as well as the ion blower nozzles, ion blower pistols and distributors may be connected with a permanently connected high-voltage cable.



Warning!

In applications involving moving bars, the high voltage cable must be attached such that there is no cable movement near the connection zone of the power supply unit.

If no discharging bar is connected to the respective plug connection of the power supply, the connection must be closed with the blind plug supplied.

3.3.1 Maximum active bar length and length of the high voltage cable



Both the lengths of the high voltage cable and of the active bars are limited. The shielded high voltage cables cause a capacitive load on the transformer inside the power supply.

The load increases at higher discharge frequencies. The maximum load to be connected is reduced with the reciprocal value of the frequency change (frequency doubling = halving the loading capacity). The maximum loading capacity is a result of the function of the total active bar length, the total length of all high voltage cables and the discharge frequency.

Fig. 6 demonstrates this relationship for R50 bars, R36E ion blower nozzles, R55E ion blower heads and PR36 / PR55 ion blower pistols at different values.

Fig. 6:
Loading capacity of the power supply as factor of bar length and length of high voltage cable of R50 bars, R36E, R55E, PR36, PR55

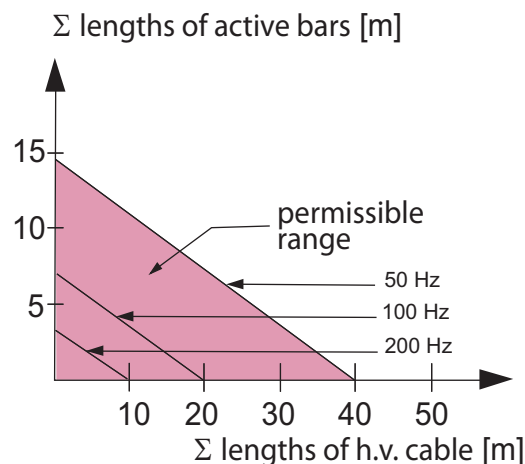

Example:
The maximum permissible total cable length with a 3 meter active bar length is 32 meters.

Z01171e

Fig. 7 demonstrates this relationship for R47 and R6x bars at different values.

*Fig. 7:
Loading capacity
of the power
supply as factor of
bar length and
length of high
voltage cable of
R47 and R6x bars*

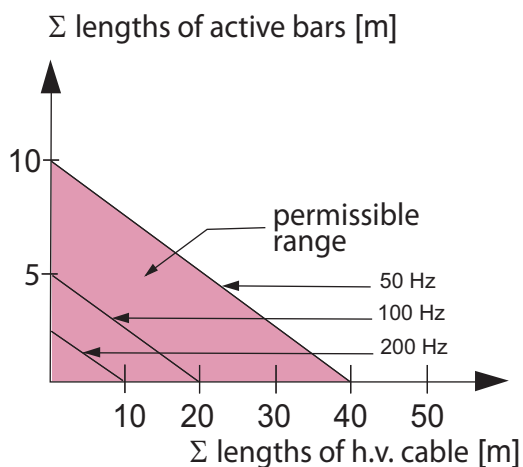

Note:

The details of the maximum connectable cable length or active bar length refer to the maximum setting of the discharge voltage setpoint. If this setting is reduced, the maximum connectable length for the bars and high voltage cables increases.



When connecting several devices (bars, ion blower nozzles, ion blower heads) using an ESVY61 / ESV61 high voltage distributor, the total active bar and cable length must be within the permissible range of the loading capacity diagram (Fig. 6 / Fig. 7).

Z01172e

3.3.2 Connecting the high voltage cable



Warning!

Electric shock hazard!

Work may be carried out only if:

- the supply voltage to the power supply has been disconnected
- the machine is at a standstill, as the bars pick up charge while the material web is running.

Connect the discharge bars to the power supply using the prefabricated high voltage cable. Push the high voltage cables into the sockets up to the stop. Then secure the adapter in the socket with the clip (see Fig. 8). Cables without adapter carry a colored marking on the flexible tubing. This marking must lie flush with the outside edge of the coupling. Cables without flexible tube and cables with plug-type adapters are plugged in flush and secured with the clip.

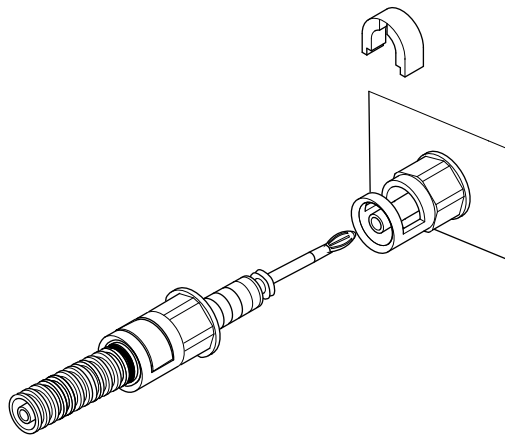

*Fig. 8:
Connecting the
high voltage
cables*

200004y



Warning!

For applications involving moving bars, the high voltage cable must be attached such that there is no cable movement near the connection zone of the power supply unit.

If no discharging bar is connected to the respective plug connection of the power supply, the connection must be closed with the supplied blind plug.

Disconnect and/or connect the bars only when the power supply is switched off.

3.3.3 Disconnecting the high voltage cable



Warning!

Electric shock hazard!

Work may be carried out only if:

- the supply voltage to the power supply has been disconnected,
- the machine is at a standstill, as the bars pick up charge while the material web is running.

3.4 Connecting the supply voltage



Warning!

Electric shock hazard!

Work may be carried out only if:

- the supply voltage to the power supply has been disconnected
- the machine is at a standstill, as the bars pick up charge while the material web is running.

To ensure that no high voltage is applied at the bars when the machine is not running, the supply voltage to the power supply should be enabled via a machine contact which disables the high voltage when the machine is at rest.

3.4.1 Connecting the supply voltage DC (ES61/_D)

The supply voltage of the power supply is connected to the 24 V DC supply network via the 4-pin circular connector.

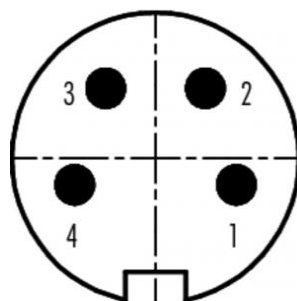

	wire color
1 +24 V DC	white
2 +24 V DC	brown
3 0 V and grounding	green
4 0 V and grounding	yellow

Fig. 9:
Pin assignment
24 V DC plug
supply voltage

F00061y

For device versions with a permanently connected mains cable, please note the different, correct wire assignment:

1: 24 DC 2: 0 V ye/gr: PE



Caution!

Due to the power consumption of the power supply unit, the cable cross-sections should be as large and the cables as short as possible in order to reduce cable loss.

The voltage at the individual contacts must not exceed 60 V DC.

3.4.2 Connecting the supply voltage AC (ES61/_A)

The supply voltage of 90 - 264 V AC is connected via the prefabricated mains cable with angled shock-proof plug or open ends for connection to terminals in the control cabinet.

3.4.3 External protection

For external fusing of the power supply unit, we recommend the following circuit breaker, depending on the design variant:

ES61/A: 2 A, Tripping-Characteristics "C"

ES61/D: 4 A, Tripping-Characteristics "D"

3.5 Sensor input (optional)

only variantes ES61/_...C and ES61/_...S
see table Pos. 6, chapter 1.4 "Variants", page 10

The interface enables the connection of an E-field sensor or speed sensor. It is also possible to connect an external expansion box for evaluating several sensors.

To use the sensor input, select the corresponding parameter setting, see chapter A.3.4 "Parameters Sensor", page 101.



Caution!

- Please ensure that the signals are connected correctly to avoid damaging the power supply unit.
- Shielded cables must always be used for the interface cables; the shields must be connected at both ends.
- The voltage at the individual contacts must not exceed 60 V DC.

Sensor input pin assignment

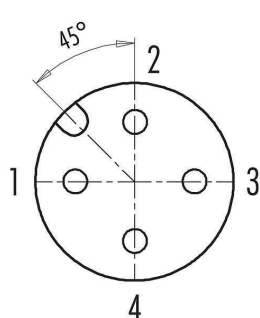

- | | |
|---|--|
| 1 | GND |
| 2 | +24 V DC output, $\pm 20\%$, $I < 50\text{ mA}$ |
| 3 | analog sensor input |
| 4 | digital sensor input |
| | 0 V |
| | digital Low |
| | 24 V DC |
| | digital High |

Fig. 10:
Sensor input
pin assignment

When using a speed sensor, ensure that a suitable speed sensor with a supply voltage of 24 V DC and a PNP sensor output is used.

The external expansion box for evaluating additional sensors must be connected to the two connections GND and digital sensor input. For further information, please refer to the documentation for the expansion box.

F00076y

3.6 I/O interface (optional)

only variants ES61/_...C and ES61/_...R
see table Pos. 6, chapter 1.4 "Variants", page 10

The interface enables the power supply unit to be integrated into a PLC or other environments for function and fault signal monitoring. Hardware release is optional.



Caution!

- Please ensure that the signal lines are connected correctly to avoid damaging the power supply unit.
- Shielded cables must always be used for the interface cables; the shields must be connected at both ends.
- The voltage at the individual contacts must not exceed 60 V DC.

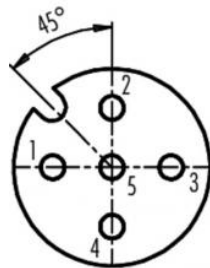

Fig. 11:
Sensor input
pin assignment

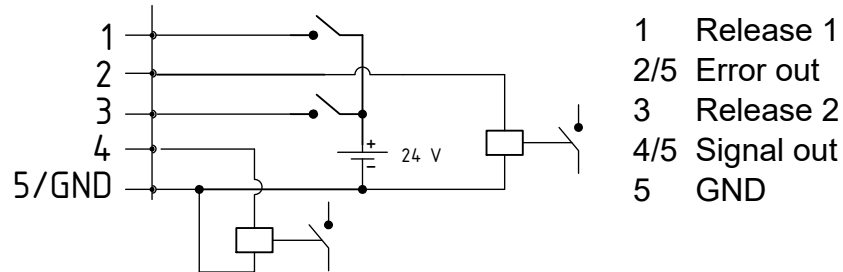

Fig. 12:

1 Release 1

wire color: white

External 24 V signal for releasing the high voltage

$U = 24 \text{ V DC } \pm 10 \%$, $I < 20 \text{ mA}$

For further details on the release circuit, see chapter 4.4 "Releasing the high voltage", page 37.

F00052y

Z-118:404y_8

2 Fault signal output

wire color: brown

0 V:

The power supply is not ready to start or has detected an error; the high voltage is switched off.

24 V DC:

The power supply is in operation and no errors have occurred.

24 V DC / $I < 50 \text{ mA}$

3 Release 2

wire color: green

External 24 V signal for releasing the high voltage

$U = 24 \text{ V DC} \pm 10 \%$, $I < 20 \text{ mA}$

For further details on the release circuit, see chapter 4.4 "Releasing the high voltage", page 37.

4 Signal output

wire color: yellow

24 V signal for signaling internal device statuses.

For more informationen, see chapter 4.3 "Function monitoring", page 31.

24 V DC / $I < 50 \text{ mA}$

5 GND

wire color: grey

3.7 Field bus Interfaces



Warning!

Electric shock hazard!

Work may be carried out only if:

- the supply voltage to the power supply has been interrupted
- the machine is at a standstill, as the bars pick up charge while the material web is running.



Caution!

The voltage at the individual contacts must not exceed 60 V DC.

3.7.1 CANopen® (optional)

The ES61 power supplies support the CANopen® protocol standardized according to CiA 301. The power supply logs on to the network as a slave with the device profile 401 for input/output devices. The following CANopen® services are supported:

- Emergency Protokoll (EMCY) for the transmission of error and warning events
- Heartbeat Producer for node monitoring
- Static mapping for PDO transfer
All important data are available in PDOs.
- Immediate SDO transfer
Segmented transfer and block transfer are not supported.
- CANopen® objects for storing und restoring parameter data
- CANopen® objects for saving and restoring parameter data
- LSS services for setting the node address and baud rate (see Chapter 4.5).

The complete description of the CANopen® protocol for the ES61 power supply and the corresponding EDS file "ES61.eds" are available in separate files. The files are available for download on the product page Discharge/Power Supplies/PRO IONIZER at www.eltex.de.

The bus network (beginning / end) has to be terminated at both sides.

Pin assignment CANopen®

Plug connector M12x1 A-coded

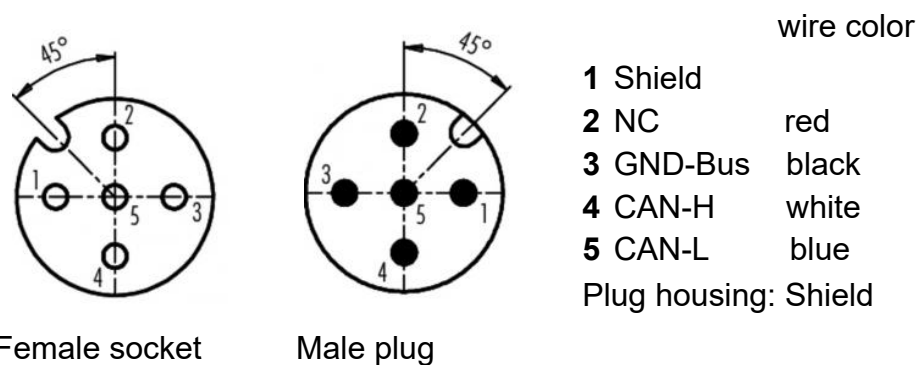

Fig. 13:
Pin assignment
CAN-Bus female/
male

F00062y + F00063y



Caution!

For the variant with CANopen®, a cable suitable for CAN bus networks with a surge resistance of 120 ohms must be used for both bus leads; this is the only way to ensure the proper functioning of the CAN network.

The maximum cable lengths specified in CiA 303-1 as a function of the transmission speed must be observed for the entire network and for the individual spur lines.



Caution!

A warning message appears if the bus communication is not connected. The occurrence of this warning message can be suppressed by deactivating the CANopen® communication; see chapter 4.5.1.10.7 "CANopen® Baud rate", page 48 for setting using the membrane keyboard and chapter 4.5.2.5.3 "General Parameters", page 67 for the setting via the display.

3.7.2 ModbusTCP (optional)

only variants ES61/_...M

see table Pos. 7, chapter 1.4 "Variants", page 10

The power supplies of the ES61/_M family can be integrated into an existing LAN network using the TCP/IP standard ModbusTCP protocol.

All variants with this option support the following functions:

- 10/100 Mbit/s transmission
- DHCP protocol for setting the IP address (activated by default)
- Fixed IP address setting is possible
- Cyclic retrieval of process data
- Setting and reading of the parameter set
- LED output of the network and connection status

A complete description of supported commands and assignment of process data, parameters etc. of the respective registers are available in separate files. The files are available for download on the product page Discharge/Power Supplies/PRO IONIZER at www.eltex.de.



Caution!

Suitable, shielded cables must be used to connect the power supply unit to the network; the shield must be contacted at a suitable point at both ends. We recommend using cables of category Cat 5e or higher.

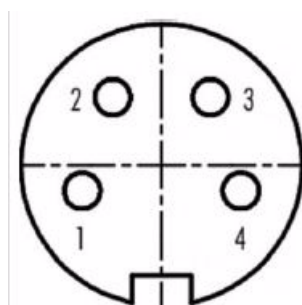

- | | |
|---|------|
| 1 | Tx + |
| 2 | Rx + |
| 3 | Tx - |
| 4 | Rx - |

Fig. 14:
Pin assignment
Plug connector
M12x1 D-coded

2 x female Socket

F00055y



3.8 Use of the Eltex signal cable CS and mains cable KN

When using the CS signal cable or the KN mains cable optionally available from Eltex, the following data, color markings and bending radii should be observed when connecting the individual leads.

Available cable variants

- **CS/E Signal cable I/O interface**
 - CS/EMO connection power supply: straight plug
connection customer: open end
- **CS/C Signal cable CANopen®**
 - CS/CFFG connection power supply: straight socket
connection customer: straight socket
 - CS/CFFW connection power supply: straight socket
connection customer: angled socket
 - CS/CFMG connection power supply: straight socket
connection customer: straight plug
 - CS/CFMW connection power supply: straight socket
connection customer: angled plug
 - CS/CFO connection power supply: straight socket
connection customer: open end
 - CS/CMFG connection power supply: straight plug
connection customer: straight socket
 - CS/CMFW connection power supply: straight plug
connection customer: angled socket
 - CS/CMMG connection power supply: straight plug
connection customer: straight plug
 - CS/CMMW connection power supply: straight plug
connection customer: angled plug
 - CS/CMO connection power supply: straight plug
connection customer: open end
- **CS/C Signal cable Fieldbus Industrial Ethernet**
 - CS/IMMG connection power supply: straight plug
connection customer: straight plug
 - CS/IMMW connection power supply: straight plug
connection customer: angled plug
 - CS/IMR connection power supply: straight plug
connection customer: RJ45 plug
- **KN/H Mains cable Supply voltage 24 V**
 - KN/HD connection power supply: straight plug
connection customer: open end

Cable assignment for open end connection

CS/E Signal cable I/O interface

Core no.	Core color	Signal
1	white	release 1
2	brown	fault signal output
3	green	release 2
4	yellow	signal output
5	gray	fault signal output
	shirm	GND

CS/C Signal cable CANopen®

Core no.	Core color	Signal
2	red	+24 V DC output (optional)
3	black	GND bus
4	white	CAN-H
5	blue	CAN-L
	shield	ground potential

KN/H Mains cable Supply voltage 24 V DC

Core no.	Core color	Signal
1	white	+24 V DC
2	brown	+24 V DC
3	green	0 V
4	yellow	0 V

Bending radii

When installing the cables, observe the following minimum bending radii:

Cable	CS/E	CS/C	CS/I	KN/H
fixed	34.8 mm	55.0 mm	35.0 mm	36.6 mm
moving	87.0 mm	110.0 mm	100.0 mm	91.5 mm

4. Operation

In all power supply variants, the operating status of the device is indicated by LEDs.

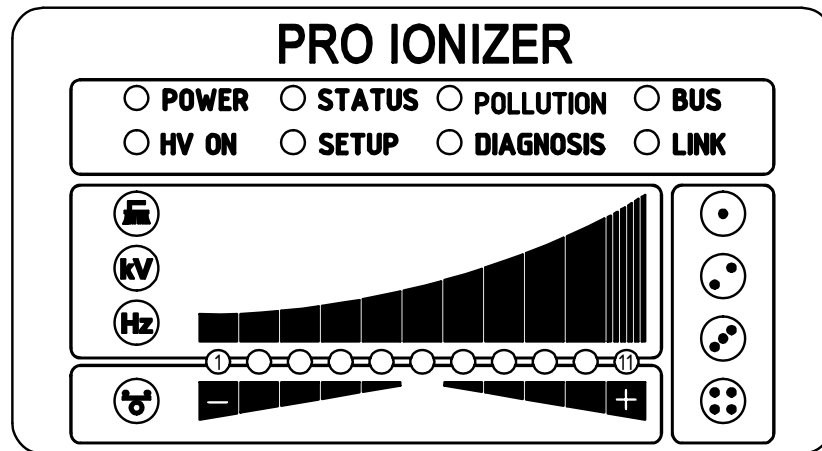

Fig. 15:
Operating status
indicated by
illuminated LED

Z-118404ay_6

4.1 Startup

If all connections and the installation have been carried out correctly, the system is ready for operation and the supply voltage can be switched on.

4.2 Setting the power supply ES61

After switching on, the individual settings for the individual parameters are shown on the LED display on the power supply unit. The device is already ready for operation during this display. It is not necessary to wait for the display until the high voltage is enabled.

The discharge result can be influenced and optimized by the parameters discharge voltage, ion balance and frequency.

The achievement of the optimum discharge power can be checked with an electric field meter by measuring the product to be discharged. We generally recommend using the factory settings of these parameters (see chapter A.3.1 "Parameters Discharge", page 97).

For more information on the best possible setting of the high voltage for optimizing the residual charge, see chapter A.4 "Optimization of the residual charge", page 104.

kV - Discharge voltage

The setpoint of the discharge voltage can be varied within a range of 3.5 - 5 kV.

The ionization range can be extended by increasing the voltage. The discharge voltage also affects the ion balance. Reducing the discharge voltage improves the ion balance.

- Ion Balance

The ion balance can be set for both polarities to optimize the residual charge.

If only the middle LED of the bar lights up, there is no adjustment. If LEDs in the left-hand area light up, the ion balance is shifted in the negative direction. An adjustment in the positive direction takes place when the LEDs in the right-hand area of the bar light up.

Hz - Frequency Discharge

The frequency can be varied in several stages within a range of 50 - 200 Hz

The residual charge of the substrate to be discharged can be optimized by changing the frequency, see chapter A.4 "Optimization of the residual charge", page 104.

When operating at higher frequencies, the load on the power supply unit increases (see chapter 3.3.1 "Maximum active bar length and length of the high voltage cable", page 17, load diagrams).

Brush

The current actual pollution value of the selected connection is displayed. For more information on the pollution monitoring, see chapter A.5 "Pollution monitoring", page 106.

4.3 Function monitoring

The correct functioning of the unit is signaled via LEDs. In addition, function monitoring is possible with the optional fault signal and signal outputs of the I/O interface.

Note!

Malfunctions are not saved. The disruption of the supply voltage automatically cancels the malfunction message.

The following list and description of the individual LEDs on the LED display describes the display when the device is in operation. When the setup menu is activated (see LED SETUP), the display for individual LEDs differs from the status described; for further information, see chapter chapter 4.5.1.10 "Setup menu Device settings", page 41 and chapter 4.5.1.11 "Setup menu Performance Control", page 49.

• LED POWER

LED POWER	State
OFF	Power supply OFF or power supply error
Green steady light	Power supply ON

• LED "HV ON"

LED HV ON	State
OFF	High voltage OFF
Green steady light	High voltage ON

- **LED "STATUS"**

LED STATUS	State
Red steady light	Initializing
Red flashing	Error
Red 1 x flashing	System error
Green steady light	Hight voltage ON
Green flashing	Warning and High voltage ON
Green 1 x flashing	Power supply in standby mode High voltage OFF
Green 2 x flashing	Warning and High voltage OFF

- **LED "SETUP"**

LED SETUP	State
OFF	Device in normal operation Setup menu not active
Yellow steady light	Setup menu active
Yellow steady flashing	Pollution monitoring for currently selected connection deactivated

- **LED "POLLUTION"**

only variants ES61/P

see table Pos. 1, chapter 1.4 "Variants", page 10

POLLUTION LED	State
OFF	No pollution detected
Yellow steady light	Pollution detected
Yellow 1 x flashing	Calibration of the pollution monitoring active
Yellow flashing	Pollution calibration warning

- **LED "DIAGNOSIS"**

only variants ES61/_...P

see table Pos. 8, chapter 1.4 "Variants", page 10

DIAG LED	State
OFF	No diagnostic error detected
Red steady light	Dagnostic error detected

- **BUS LED, LINK LED**

Indicates the status of the respective bus network. In variants without field bus support, these LEDs are permanently off.

CANopen® (optional)

Display only for variants ES61/_...C

see table Pos. 7, chapter 1.4 "Variants", page 10

Presentation of the LED outputs for the CAN bus specified according to CiA 303-3.

BUS LED	State
OFF	CANopen® not initialized
Green steady light	CANopen® Device in OPERATIONAL state
Green 1 x flashing	CANopen® device in STOPPED state
Green slowly flashing (2,5 Hz)	CANopen® device in PREOPERATIONAL state
Red / Green flashing alternately (10 Hz)	Automatic baud rate detection or LSS Service in progress
Red steady light	CAN Controller is disabled
Red 1 x flashing	Transmission of too many error frames via the CAN bus
Red 2 x flashing	CANopen® error monitoring event
Red 3 x flashing	CANopen® Sync error
Red / Green flashing alternately flashing (different, changing flashing duration)	CANopen® communication error, restart device

ModbusTCP (optional)

only for variants ES61/_...M

see table Pos. 7, chapter 1.4 "Variants", page 10

BUS LED	State
OFF	No IP address assigned
Green steady light	Modbus messages received correctly
Green flashing	Waiting for first Modbus message
Red steady light	Invalid IP address

LINK LED	State
OFF	No connection
Green steady light	100 Mbit/s connection detected
Green flashing	100 Mbit/s data interchange
Yellow steady light	10 Mbit/s connection detected
Yellow flashing	10 Mbit/s data interchange

- **BAR LED**

Visual display of the actual values of the discharging voltage, the pollution of the selected connection or the parameter value of the ion balance or the discharge frequency.

The display is basically divided into 3 parts. On the left-hand side are the LEDs for visualizing the currently selected display status; on the right-hand side are the corresponding LEDs for displaying the selected connection. This area is only used in display mode for the pollution of one connection.

The LED bar is located between the two displays for the selected display status. The LED bar is divided into 11 steps for displaying the respective parameter or actual value (LED 1 left to LED 11 right).

The individual states of the LED bar for displaying the corresponding parameter or actual value are described below.

- **Brush LED**

- **Green steady light**

- only for variants ES61/P,
see table Pos. 1, chapter 1.4 "Variants", page 10

- LED 1 Yellow steady light
Display of the percentage of pollution Connection 1
 - LED 2 Yellow steady light
Display of the percentage of pollution Connection 2
 - LED 3 Yellow steady light
Display of the percentage of pollution Connection 3
 - LED 4 Yellow steady light
Display of the percentage of pollution Connection 4

- **kV LED**

- **Green steady light**

- Display of the current actual value of the discharge voltage.
When the + or - button is pressed, the display briefly changes to show the set parameter value of the discharge voltage; for more information, see chapter 4.5.1 "Using the membrane keyboard", page 38.

- **Hz LED**

- **Green steady light**

- Display of the parameterised frequency of the discharge voltage**

- 1. LED - Frequency Discharge voltage 50 Hz
 - 2. LED - Frequency Discharge voltage 62,5 Hz
 - 3. LED - Frequency Discharge voltage 75 Hz
 - 4. LED - Frequency Discharge voltage 87,5 Hz
 - 5. LED - Frequency Discharge voltage 100 Hz
 - 6. LED - Frequency Discharge voltage 125 Hz
 - 7. LED - Frequency Discharge voltage 150 Hz
 - 8. LED - Frequency Discharge voltage 175 Hz
 - 9. LED - Frequency Discharge voltage 200 Hz

- **Balance LED**

- **Green steady light**

- Display of the set parameter value of the ion balance. The centre of the LED bar represents the starting point of the display. Depending on the setting, the LEDs to the right or left of the centre point light up.

Fault signal output (optional)

only for variants ES61/_...C and ES61/_...R,
see table Pos. 6, chapter 1.4 "Variants", page 10

Display of the function	State
0 V	Error or the power supply is not ready for operation
24 V	Power supply switched on, no error occurred

Signal output (optional)

only for variants ES61/_...C and ES61/_...R,
see table Pos. 6, chapter 1.4 "Variants", page 10

The signal output can be used to signal different internal device statuses depending on the set mode; for more information see chapter A.2 "Overview of actual values", page 94.

"High voltage active" mode

Display of the function	State
0 V	High voltage OFF
24 V	High voltage ON

"Warning" mode

Display of the function	State
0 V	No warning occurred
24 V	Warning occurred

"Pollution" mode

Display of the function	State
0 V	No pollution of a device detected
24 V	Pollution detected

4.4 Releasing the high voltage

Several options are available for releasing the high voltage. These may differ depending on the device variant.



Attention!

If electrically conductive substrates or substrates coated with conductive material (e.g. metal foil or metal composites) are used, the release of the high voltage must be blocked. The substrate is discharged via passive operation of the connected bars discharge.

The software release options for the high voltage are available in all devices; the hardware release options are only available for the ES61/_...C and ES61/_...R variants, see table item 6, chapter 1.4 "Variants", page 10. The "Release 1" and "Release 2" signals are logically linked internally. Only one of the two signals needs to be connected to release the high voltage.

In principle, the options for hardware and software release can be used or combined independently of each other.

When using the power supply unit in conjunction with functional safety in accordance with DIN EN 13849, redundant switching of the release is necessary. For this purpose, the two signals "Release 1" and "Release 2" must be switched separately.

Software release options

- **Automatic**
The software is released automatically once the power supply has booted up.
- **Integrated control**
The release is activated or deactivated directly by pressing a button (ON/OFF) on the integrated control unit.
Operating the power supplies with the ECC visualization system, a power supply release - set on the ECC - has priority. A deactivation at the power supply is not possible if the release has been set on the visualization system ECC at the same time. The power supply must be deactivated via the ECC visualization system.
- **CANopen®**
The release can be set or deleted via the CANopen® bus transmitted command.
- **Ethernet-based field bus**
The release can be controlled via the Ethernet-based field bus (e.g. ModbusTCP).

For more information on configuring the individual release options, see chapter A.2 "Overview of actual values", page 94.

4.5 Integrated control elements

Settings on the power supply are made via the integrated control elements. Error and warning messages can be acknowledged directly on the device.

Depending on the power supply variant, the operator can use the integrated membrane keyboard or the touchscreen.

4.5.1 Using the membrane keyboard

only for variants ES61/_...K,
see table Pos. 5, chapter 1.4 "Variants", page 10

The keyboard is used to set certain parameters, the setpoint and to acknowledge error and warning messages.

Note:

The membrane keyboard can be deactivated by setting the parameter for the key lock. The key lock is automatically released again after a fieldbus communication failure is detected, so that settings can be made on the device using the membrane keyboard, see chapter A.3.3 "Parameters General", page 100.

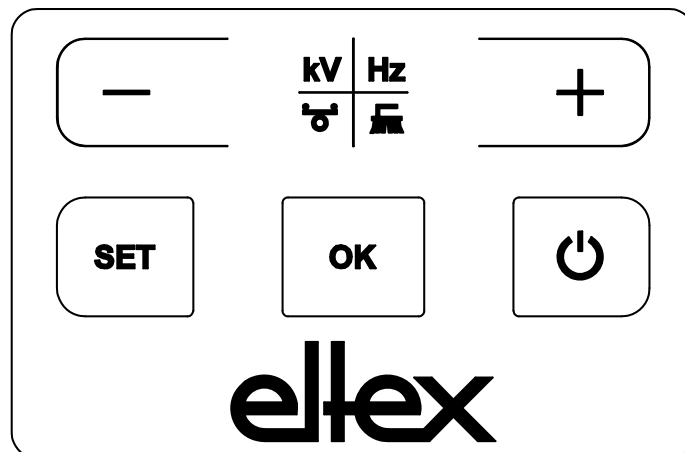

Fig. 16:
Membrane
keyboard

Z-118404y_7

4.5.1.1 Description of the buttons

- **Button: +**
Button for changing the setting
- **Button: -**
Button for changing the setting
- **Button: kV / Hz / Brush / Balance**
Button for switching the display of the LED bar
- **Button: Setup**
Activating the Setup Menu
- **Button: OK**
Conformation of the setting
- **Button: ON/OFF**
Setting or deleting the software release for high voltage generation

4.5.1.2 Switching the bar display

Pressing the kV / Hz / Brush / Balance button changes the view of the current bar display. The currently selected display is shown by the permanent illumination of the corresponding LED. In the display mode for pollution (LED brush lights up permanently), it is still possible to change the display for the individual connections. Use the +/- buttons to do this.

The change takes place each time the button is pressed or held down and is only possible when the setup menu is deactivated.

4.5.1.3 Setting the setpoint Discharge voltage

When the display mode for the discharge voltage is selected (LED kV lights up continuously), the setpoint value for the discharge voltage can be set by pressing the +/- buttons. The LED bar display changes from displaying the actual value to displaying the setpoint value immediately after the button is pressed.

The set value for the discharge voltage can be changed in the range from 3.5 kV to 5.0 kV in 100 V increments.

Once the setting has been made, the current setpoint is saved automatically. The setpoint value for the discharge voltage can only be set when the setup menu is deactivated. For more information on setting the setpoint, please refer to chapter chapter A.4 "Optimization of the residual charge", page 104.

If the setting for permanent activation of the reference point is selected, the setpoint of the discharge voltage cannot be changed via the membrane keypad. For more information, see chapter 4.5.1.11.2 "Activation reference point", page 51.

4.5.1.4 Setting the frequency Discharge voltage

The frequency of the discharge voltage can be set using the +/- buttons of the LED bar when selecting the display mode for the frequency (LED Hz lights up continuously). The frequency is set in steps in a range of 50 - 200 Hz.

1. LED - Frequency Discharge voltage 50,0 Hz
2. LED - Frequency Discharge voltage 62,5 Hz
3. LED - Frequency Discharge voltage 75,0 Hz
4. LED - Frequency Discharge voltage 87,5 Hz
5. LED - Frequency Discharge voltage 100,0 Hz
6. LED - Frequency Discharge voltage 125,0 Hz
7. LED - Frequency Discharge voltage 150,0 Hz
8. LED - Frequency Discharge voltage 175,0 Hz
9. LED - Frequency Discharge voltage 200,0 Hz

Once the setting has been made, the current frequency is saved automatically. The discharge voltage frequency can only be set when the setup menu is deactivated.

To set the frequency in connection with optimizing the residual charge of the substrate to be discharged, please refer to chapter A.4 "Optimization of the residual charge", page 104.

If the setting for permanent activation of the reference point is selected, the cannot be changed via the membrane keypad. For more information, see chapter 4.5.1.11.2 "Activation reference point", page 51.

4.5.1.5 Setting the ion balance

If the Balance display mode (LED Balance lights up continuously) is selected, the ion balance can be set by pressing the +/- buttons.

The ion balance can be adjusted in both the positive and negative directions.

If only the middle LED of the bar lights up, there is no adjustment. If LEDs in the left-hand area light up, the ion balance is shifted in the negative direction. An adjustment in the positive direction takes place when the LEDs in the right-hand area of the bar light up.

Once the setting has been made, the current ion balance is automatically saved. The ion balance can only be set when the setup menu is deactivated.

The ion balance setting is used to adjust the residual charge. For more information on the setting, please refer to chapter A.4 "Optimization of the residual charge", page 104.

If the setting for permanent activation of the reference point is selected, it is not possible to change the ion balance using the membrane keypad. For more information, see chapter 4.5.1.11.2 "Activation reference point", page 51.

4.5.1.6 Setting and deleting the software release

Press the ON/OFF button to set or delete the software release. The "Release via integrated control elements" setting must be activated (default setting).

4.5.1.7 Saving the parameters

To save the entire parameter set, press and hold the OK button until the LEDs flash twice.

4.5.1.8 Loading the factory settings

To load the factory settings, press and hold the "-" and "+" and "OK" buttons until the LEDs flash twice.

4.5.1.9 Acknowledge error or warning messages

Error and warning messages can be acknowledged via a common button combination. To do this, press and hold the three buttons Setup, OK and kV / Hz / Brush / Balance until the LEDs flash twice. Acknowledgement takes place after an internal check of the system. Successful acknowledgement is indicated by the "Status" LED. If several errors or warnings have occurred, the message must be acknowledged several times.

4.5.1.10 Setup menu Device settings

The setup menu is basically divided into two parts. On the one hand, a general setup menu is available for the device settings. In addition, a setup menu for setting the performance control of the respective connection is available for the ES61/P variants see chapter 4.5.1.11 "Setup menu Performance Control", page 49).

For the device settings, the following settings are possible with the general setup menu:

- **Software release option**
Setting the options for the software release
- **Hardware release option**
only for variants ES61/...C and ES61/...R,
see table Pos. 6, chapter 1.4 "Variants", page 10
Activation or deactivation of the hardware release for the high voltage generation
- **Signal output mode**
only for variants ES61/...C and ES61/...R,
see table Pos. 6, chapter 1.4 "Variants", page 10

Selection of the mode for signaling the device status using the signal output

- **Sensor input mode**

only for variants ES61/_...C and ES61/_...S,
see table Pos. 6, chapter 1.4 "Variants", page 10

Selection of the sensor input mode

- **CANopen® node address**

only for variants ES61/_...C
see table Pos. 7, chapter 1.4 "Variants", page 10

Setting the node address of the device for the CANopen®- network

- **CANopen® baud rate**

only for variants ES61/_...C
see table Pos. 7, chapter 1.4 "Variants", page 10

Selection of the baud rate of the device for the CANopen® network or deactivation of the CANopen® communication

The setup menu is started by holding down the "Setup" button when the discharge voltage, frequency or balance of the LED bar is selected. The button must be held until the "SETUP" LED lights up continuously. Press the OK button to confirm the individual settings made. The menu then immediately switches to the next setting. The menu cannot be canceled and must be carried through to the end. When exiting the menu, the settings made are saved automatically.

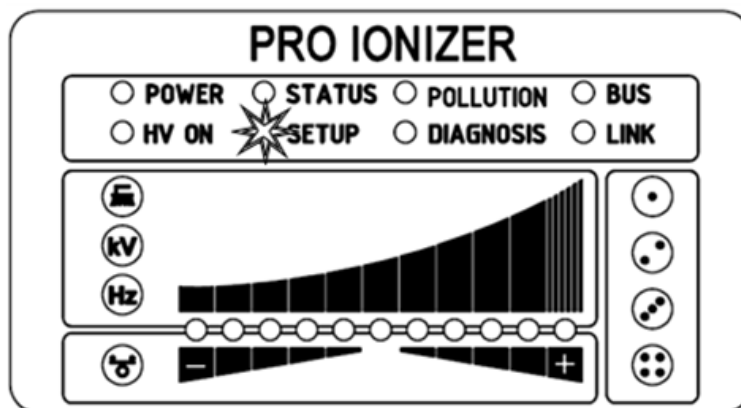

Fig. 17:
Start Setup menu
with illuminated
LED SETUP

The LEDs to the right of the LED bar show the current menu item in the setup menu. The setting is displayed using the LED bar.

B00444

4.5.1.10.1 Start Setup menu

To start the setup menu, first select the discharge voltage, frequency or balance display mode of the LED bar. Then press and hold the Setup button until the "SETUP" LED lights up continuously. Pressing the OK button takes you to the menu item for the Software release or Activate reference point option.

4.5.1.10.2 Option Software release

The 1. configuration LED indicates the selection of the menu item for setting the software release option for high voltage generation. The LED bar shows the current setting of the parameter. The setting of the software release option can be changed using the + and - buttons. The setting is confirmed by pressing the OK button.

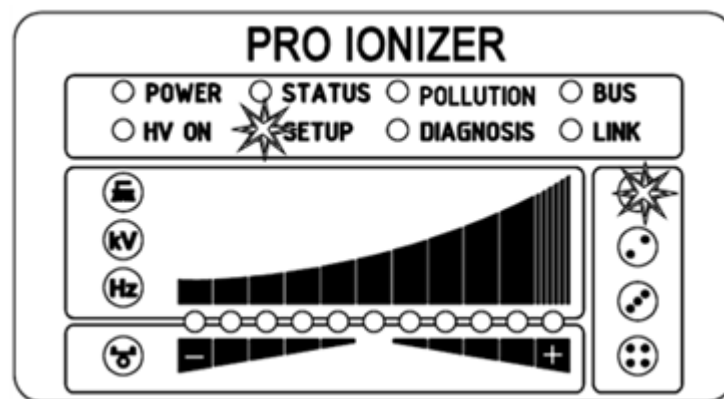

Fig. 18:
Menu item:
"Option software
release" with
illuminated 1. Con-
figuration LED

- LED 1: Software release deactivated
The high-voltage release is carried out exclusively by the external release signal via the I/O interface.
- LED 2: Automatic software release
- LED 3: Release integrated control elements membrane keyboard
Button "ON/OFF"
- LED 4: Release CANopen® interface
- LED 5: Release Ethernet-based field bus interface

B00445

4.5.1.10.3 Option Hardware release

only for variants ES61/_...C and ES61/_...R,
see table Pos. 6, chapter 1.4 "Variants", page 10

The 2. configuration LED indicates the selection of the menu item for setting the option for the hardware release of the high voltage generation. The LED bar shows the current setting of the hardware release. The setting can be adjusted using the + and - buttons. The OK button confirms the setting and the next menu item is then executed.

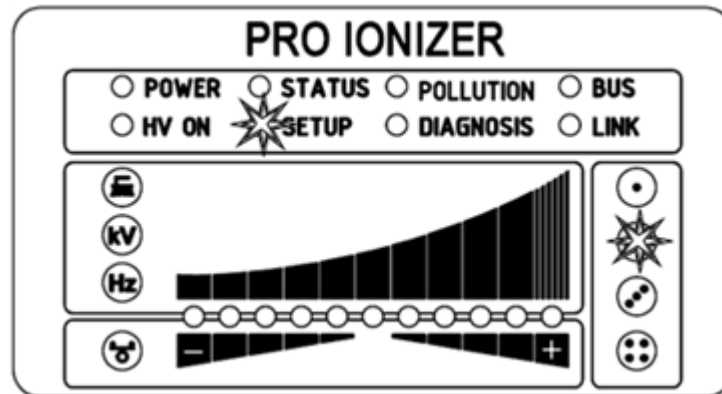

Fig. 19:
Menu item:
"Option hardware
release" with
illuminated 2. Con-
figuration LED

LED 1: Hardware release deactivated

LED 2: Hardware release activated

B00446

4.5.1.10.4 Signal output mode

only for variants ES61/_...C and ES61/_...R,
see table Pos. 6, chapter 1.4 "Variants", page 10

The menu item for setting the mode for the signal output is signaled by the 3. configuration LED. The LED bar shows the current setting of the parameter. To change the setting, press the + or - button. Press OK to confirm the setting.

Fig. 20:
Menu item:
"Signal output
mode" with
illuminated 3. Con-
figuration LED

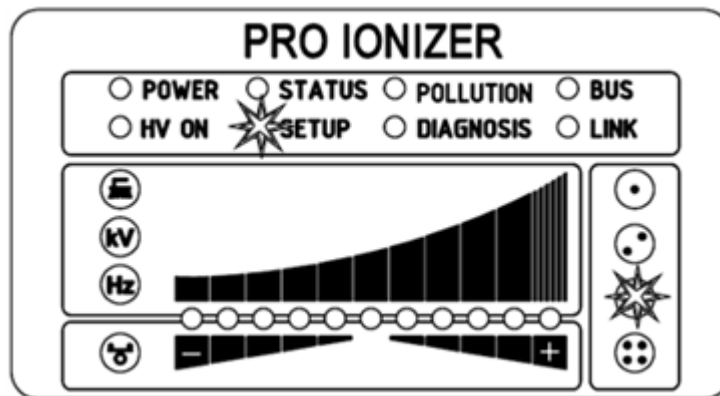

- LED 1: Signal output mode: High voltage active
- LED 2: Signal output mode: Warning
- LED 3: Signal output mode: Pollution

B00447

4.5.1.10.5 Sensor input mode

only for variants ES61/_...C and ES61/_...R,
see table Pos. 6, chapter 1.4 "Variants", page 10

The 4. configuration LED indicates the selection of the menu item for setting the sensor input mode. The currently selected mode of the sensor input is shown by the LED bar. Use the + and - buttons to set the mode. Press the OK button to confirm the setting. For device variants with CANopen® support, the setup menu changes to the settings for the CANopen® network. For all other variants, this is the last menu item and the setup menu must be exited by pressing the OK button again.

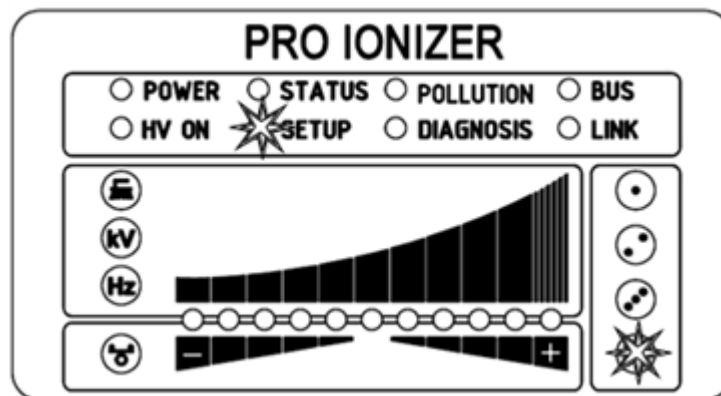

Fig. 21:
Menu item:
"Sensor input
mode" with
illuminated
3. Configuration
LED

LED 1: Sensor input mode: OFF

LED 2: Sensor input mode: Speed sensor

B00448

4.5.1.10.6 CANopen® Node address

only for variants ES61/_...C,
see table Pos. 7, chapter 1.4 "Variants", page 10

The CANopen® node address is set in two steps. First, the tens-digit of the node address is set in the range from 0 - 9. In the second step, the ones-digit is set in the range 0 - 9. The selection of the menu item is signaled by the BUS LED lighting up green continuously. The 1. configuration LED for setting the tens-digit and the 2. configuration LED for setting the ones-digit also light up. The correspondingly selected position of the LED bar represents the setting. The setting can be changed using the + and - buttons. The setting is confirmed by pressing the OK button.

Node address = (tens-digit * 10) + ones-digit

Fig. 22:
Menu item:
"Tens-digit
CANopen® node
address" with
illuminated "BUS"
LED and 1. Confi-
guration LED

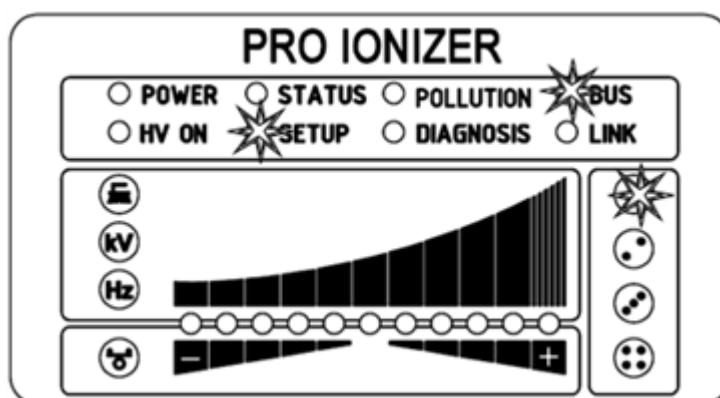

B00449

Fig. 23:
Menu item:
"Ones-digit
CANopen® node
address" with
illuminated "BUS"
LED and 2. Confi-
guration LED

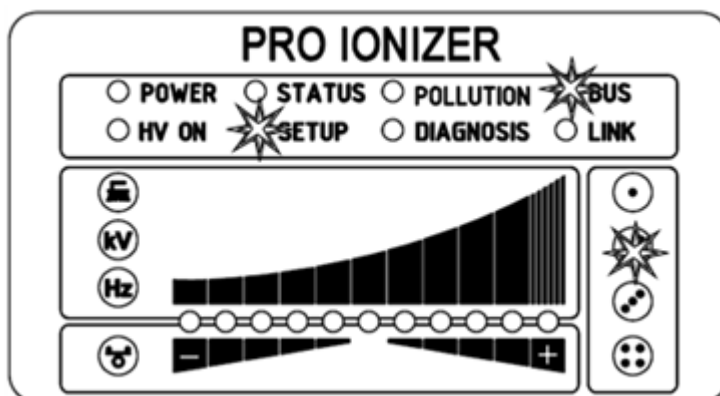

B00450

4.5.1.10.7 CANopen® Baud rate

only for variants ES61/_...C,
see table Pos. 7, chapter 1.4 "Variants", page 10

The selection of this menu item is signaled by the BUS LED and the 3. configuration LED lighting up green continuously. The currently selected setting is shown in the LED bar with the corresponding LED. Use the + and - buttons to change the setting. Finally, confirm the selection with the OK button.

Fig. 24:
Menu item:
"CANopen® baud
rate" with illumina-
ted "BUS" LED
and 3. Configura-
tion LED

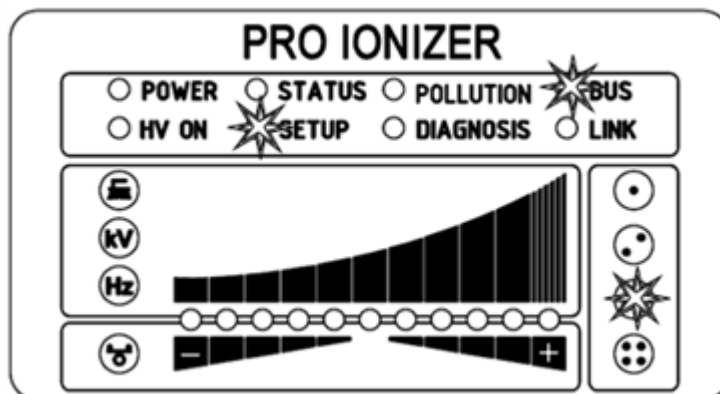

- LED 1: 1000 kBit/s
- LED 2: 800 kBit/s
- LED 3: 500 kBit/s
- LED 4: 250 kBit/s
- LED 5: 125 kBit/s
- LED 6: 50 kBit/s
- LED 7: 25 kBit/s
- LED 8: 10 kBit/s
- LED 9: Deactivation of the CANopen® communication

4.5.1.10.8 Setup Exit

Finally, exit the setup menu by pressing the OK button. All parameters are set to their respective minimum and maximum values after an internal check. The complete parameter set is then saved. The LED display flashes twice and then returns to normal display mode.

If the CANopen® node address and baud rate settings have been made, the power supply unit must be restarted. All other settings are made immediately after exiting the setup menu.

4.5.1.11 Setup menu Performance Control

only for variants ES61/P

see table Pos. 1, chapter 1.4 "Variants", page 10

The setup menu is basically divided into two parts. On the one hand, a general setup menu is available for the device settings (see chapter 4.5.1.10 "Setup menu Device settings", page 41).

In addition, a setup menu for setting the performance control of the respective high voltage connection is available for the ES61/P variants.

The ES61/P device variants support the setup menu for setting the performance control of the individual connections of the power supply unit.

The following settings are possible with this setup menu:

- Reference point activation
Setting the options for activating the reference point for performing the performance control. This setting applies to all connections, see chapter A.2 "Overview of actual values", page 94.
- Pollution monitoring
Setting the pollution monitoring of the selected connection
- Active length of the devices
Configuration of the active length of the connected device of the respective connection
- Cable length
Setting of the connected cable length of the selected connection

To start this setup menu, first select the corresponding connection to display the LED bar. To do this, press and hold the kV/HZ/Brush/Balance button until the LED brush lights up. Then select the corresponding connection by pressing the + and - buttons. The setup menu is started by holding down the Setup button. Press and hold this button until the "SETUP" LED lights up continuously. Press the OK button to confirm the individual settings made. The menu then immediately switches to the next setting.

The menu cannot be canceled and must be carried through to the end. When exiting the menu, the settings made are saved automatically.

For optimum setting and use of the Performance Control, it is recommended that the settings are made with the high voltage deactivated. The setup menu should also be carried out again after replacing the connected device.

Fig. 25:
Start
Setup menu
with illuminated
"SETUP" LED

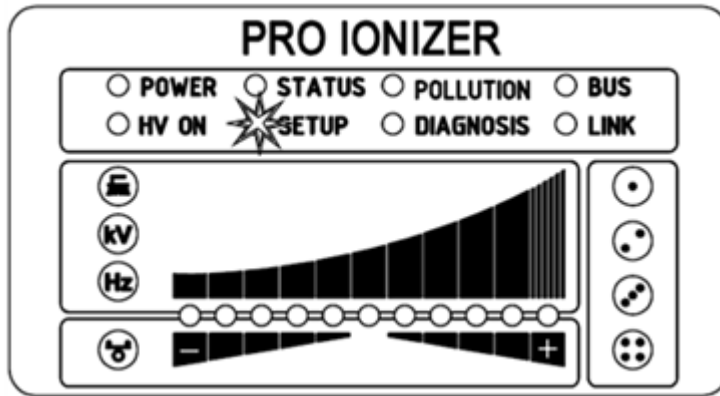

b00452

The LEDs to the left of the LED bar indicate the current menu item in the setup menu. The setting is displayed using the LED bar. The LEDs to the right of the LED bar are used to display the currently selected connection for carrying out the setup menu.

4.5.1.11.1 Start Setup menu

To start the setup menu, first select the pollution display mode (brush LED) of the connection to be configured. Then press and hold the Setup button until the "SETUP" LED lights up continuously. Press the OK button to access the menu item for the option "Activation reference point".

4.5.1.11.2 Activation reference point

The "Brush" LED signals the selection of the menu item for setting the activation of the reference point. All four connection LEDs also light up. The LED bar shows the current setting of the parameter. The + and - buttons can be used to change the setting of the software release option. To change the setting, press the + or - button. Press the OK button to confirm the setting.

The setting for activating the reference point is a general setting. This cannot be set individually for each connection. For more information on setting the activation of the reference point and pollution monitoring, see chapter A.2 "Overview of actual values", page 94.

Fig. 26:
Menu item:
"Activation
reference point"
with illuminated
"Brush" LED and
all 4 connection
LEDs

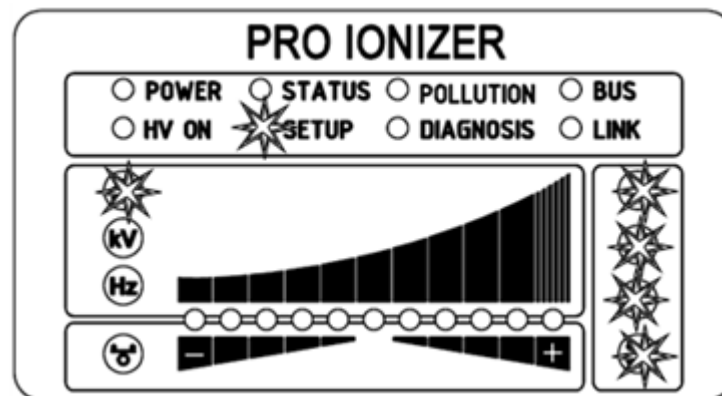

LED 1: Activation of the reference point at high voltage release

LED 2: Reference point permanently activated

LED 3: Cyclical activation, cycle time 1 minute

LED 4: Cyclical activation, cycle time 10 minutes

LED 5: Cyclical activation, cycle time 30 minutes

LED 6: Cyclical activation, cycle time 60 minutes

LED 7: Activation of the reference point by external request via optional field bus interfaces.

For further information, please refer to the corresponding protocol description.

Note:

The reference point refers to a fixed setting of the discharge voltage (5 kV, 50 Hz, 0 % ion balance), i.e. these values cannot be changed by the user during operation with a permanently operated reference point.

If the discharge voltage, frequency and/or ion balance need to be adjusted, a different setting must be selected to activate the reference point.

4.5.1.11.3 Pollution monitoring connection

The "Pollution monitoring connection" menu item is indicated by the "kV" LED lighting up. The corresponding connection LED also lights up to indicate which connection is selected for setting. The illuminated LED of the LED bar shows the current setting. The setting can be adjusted using the + and - buttons. To confirm the setting, press the OK button.

Fig. 27:
Menu item:
"Connection
pollution monitoring"
with illuminated "kV"
LED and
2. connection LED

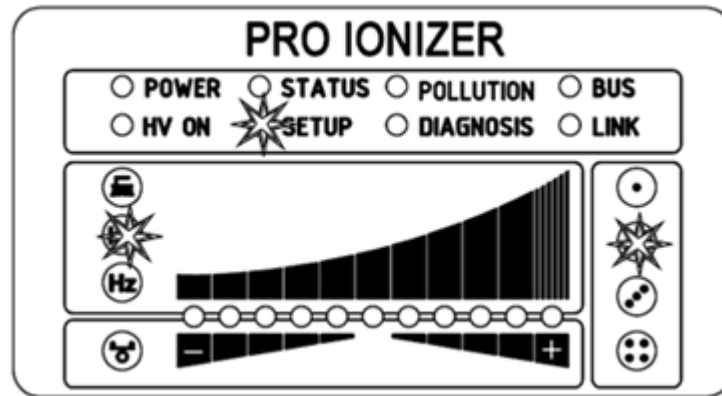

- LED 1: Pollution monitoring deactivated
- LED 2: Pollution monitoring activated
- LED 3: Calibration of the pollution monitoring

In the case of a new installation and direct activation of the pollution monitoring, the calibration is automatically selected and is performed once the next time the high voltage is switched on.

If a new calibration is required at a later time (e.g. connection of a new device), this can be selected as described above (LED 3). It is essential to ensure that the correct connection is selected.

Once the calibration has been performed, the pollution monitoring function is automatically activated.

Calibration with polluted devices leads to an incorrect evaluation of the pollution monitoring; prior cleaning of the device is absolutely necessary.

B00454

4.5.1.11.4 Active length of the device

The "Hz" LED indicates the selection of the menu item for setting the active length of the connected device of the selected connection. The corresponding connection LED also lights up to the left of the LED bar. The LED bar shows the current setting. The + and - buttons change the setting. The active length of the device can only be set in ranges. Please select the appropriate range for the connected device for the best possible pollution monitoring. The setting is confirmed by pressing the OK button.

Fig. 28:
Menu item:
"Active length
device"
with illuminated
"Hz" LED and
3. connection LED

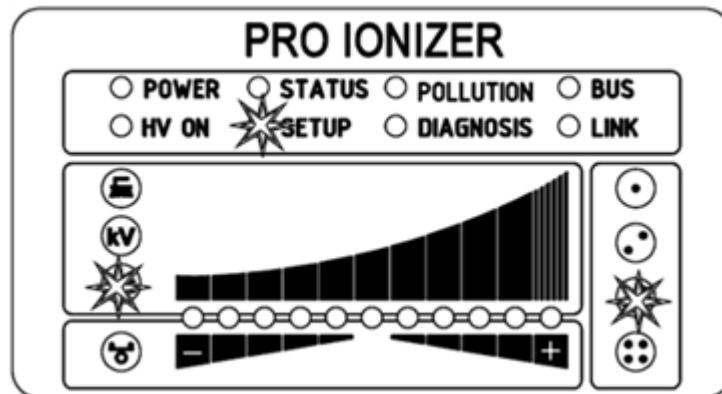

- LED 1: Active length up to 100 mm
- LED 2: Active length from 100 mm to 200 mm
- LED 3: Active length from 200 mm to 300 mm
- LED 4: Active length from 300 mm to 500 mm
- LED 5: Active length from 500 mm to 750 mm
- LED 6: Active length from 750 mm to 1000 mm
- LED 7: Active length from 1000 mm to 1250 mm
- LED 8: Active length from 1250 mm to 1500 mm
- LED 9: Active length from 1500 mm to 2000 mm
- LED 10: Active length from von 2000 mm to 2500 mm
- LED 11: Active length greater than 2500 mm

BC00455

4.5.1.11.5 Cable length

The menu item for setting the connected cable length of the respective connection is signaled by the "Balance" LED and the corresponding connection LED lighting up. The LED bar shows the current setting. This can be changed using the + and - buttons. The cable length can be set in the ranges described below. Please select the appropriate range for the connected cable length. The OK button confirms this setting.

Fig. 29:
Menu item:
"Cable length"
with illuminated
"Balance" LED
and
1. connection LED

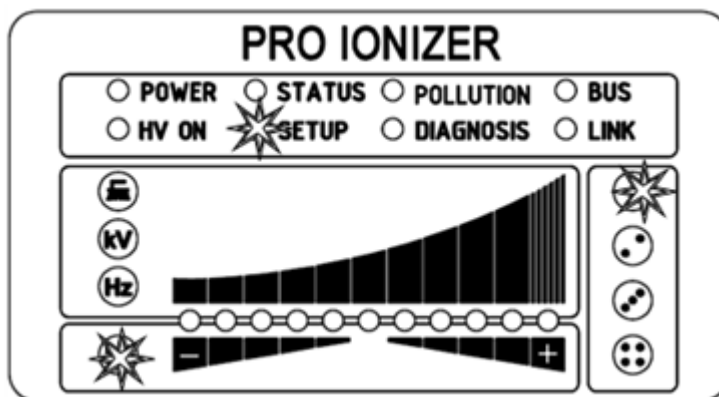

- LED 1: Cable length up to 2 m
- LED 2: Cable length in the range from 2 m to 4 m
- LED 3: Cable length in the range from 4 m to 6 m
- LED 4: Cable length in the range from 6 m to 8 m
- LED 5: Cable length in the range from 8 m to 10 m
- LED 6: Cable length in the range from 10 m to 12 m
- LED 7: Cable length in the range from 12 m to 14 m
- LED 8: Cable length in the range from 14 m to 16 m
- LED 9: Cable length in the range from 16 m to 18 m
- LED 10: Cable length in the range from 18 m to 20 m
- LED 11: Cable length greater than 20 m

4.5.1.11.6 Setup Exit

Finally, exit the setup menu by pressing the OK button. All parameters are set to their respective minimum and maximum values after an internal check. The complete parameter set is then saved. The LED display flashes twice and then returns to normal display mode.

b00456

4.5.2 Using the display

only for variants ES61/_...D,
see table Pos. 5, chapter 1.4 "Variants", page 10

The operating options of the display integrated in the power supply unit are shown below:

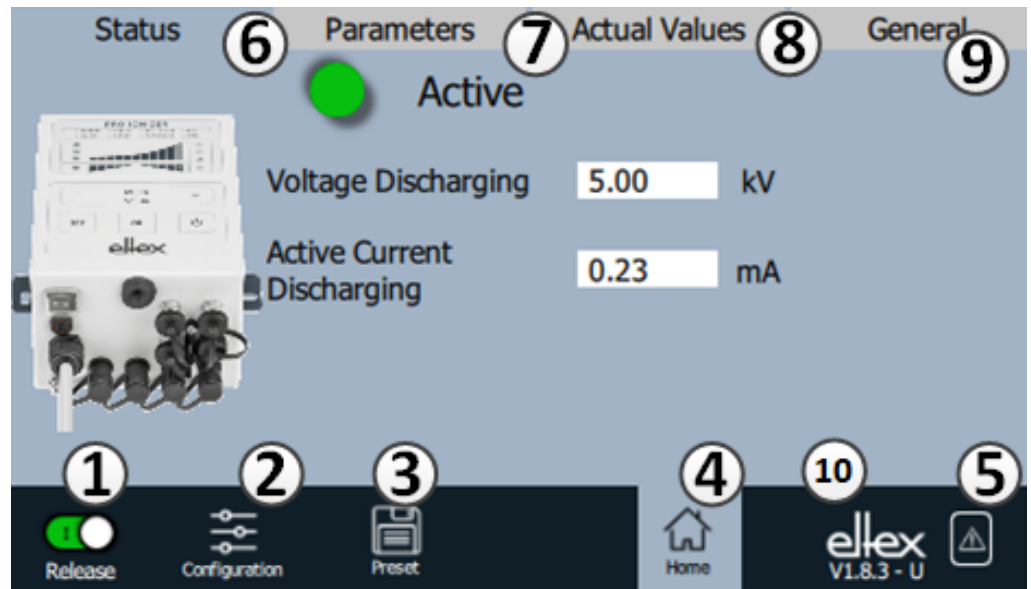

Fig. 30:
Overview of the
main menu

- 1 Release
Power supply release, high voltage settings
- 2 Configuration
Settings for configuring the screen view
- 3 Presetting
Saving and loading the presettings for power supply parameterization
- 4 Main screen
Navigation to the main screen
- 5 Message overview
Display of currently occurring error / warning messages
- 6 Status
Display of the status information of the power supply
- 7 Parameters
Display of the parameter data for setting the power supply
- 8 Actual values
Overview of all available actual values of the power supply
- 9 General
Display of general device information
- 10 Version number with current access level
V - Viewer U - User SU - Super user

4.5.2.1 Release

Press the "Release" button.

To lock or set the high-voltage release, slide the switch in the bottom left-hand corner to the relevant position. A possible password prompt must be confirmed with the correct password.

4.5.2.2 Configuration

Press the "Configuration" button.

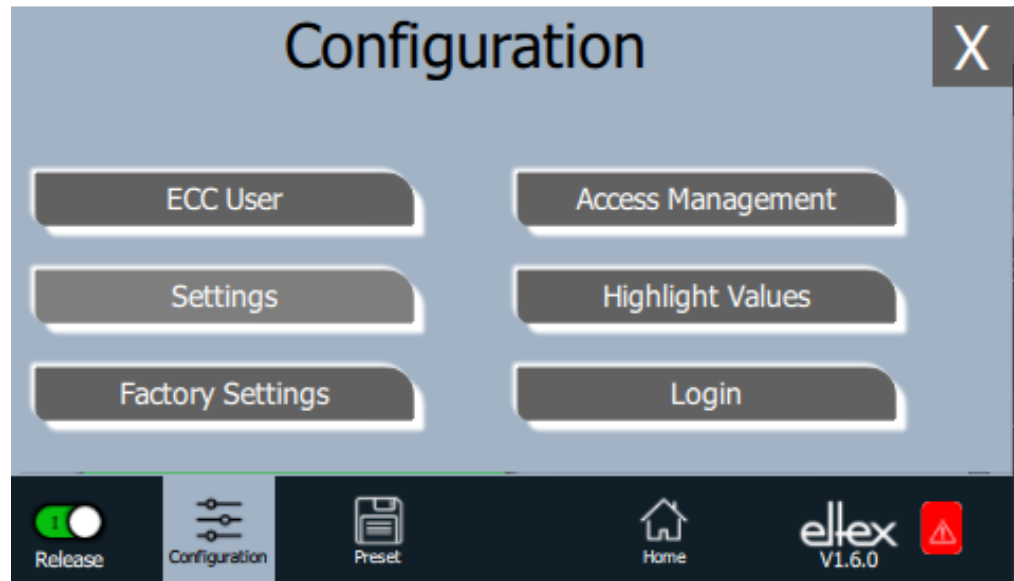

Fig. 31:
Overview of the
configuration

The view of the individual selection options for the configuration page varies depending on the current access level. The complete overview is only shown for access as a super user. For more information, see chapter 4.5.2.2.1 "ECC User", page 57.

B00441

4.5.2.2.1 ECC User

Press the "ECC user" button.

Dialog for changing the password and logging the user in or out.



Fig. 32:
Password

To change the password, enter the current password in the field "Current password", enter the new password in the field "New password" and again in the field "Confirm new password"; activate the new password with "Change password" and wait for a response.

Three password levels are available:

- Viewer
Password: 0001
- User
Password: 2819
- Super user:
Password: 3517

4.5.2.2.2 Access Management

Press the "Access Management" button.

Dialog for setting and configuring the individual parameters for the respective user level.

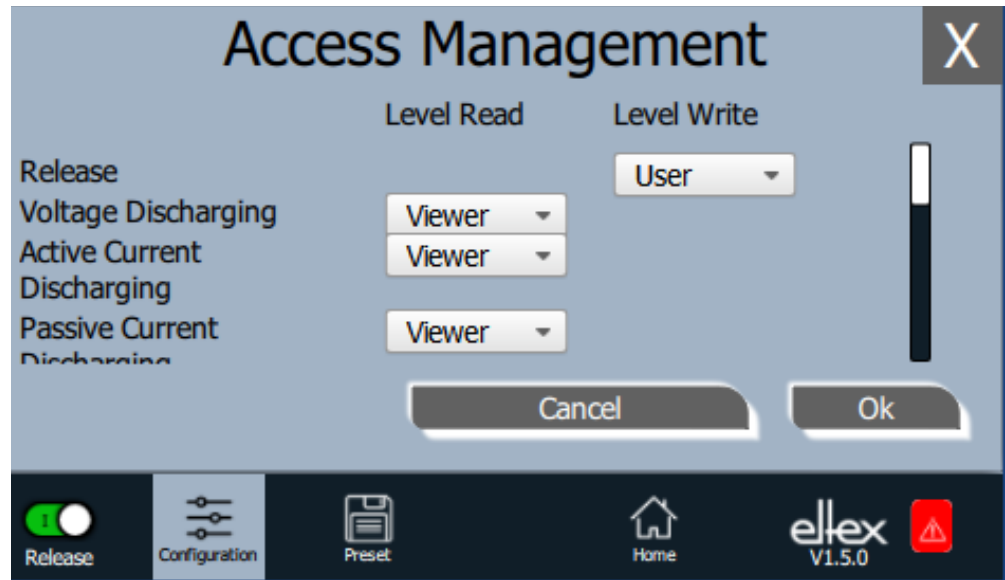

Fig. 33:
Access
Management

Select the access level in the selection list of the respective parameter and confirm with OK. If you press the "Cancel" button, changes are not applied and the last valid settings are active.

BC0438

4.5.2.2.3 Settings

Language, standard access level, indication of the voltage and current values, release query

Press the "Settings" button.

Dialog for setting the display language and the help information, setting / configuring the standard access level and display setting the display of the voltage and current values.

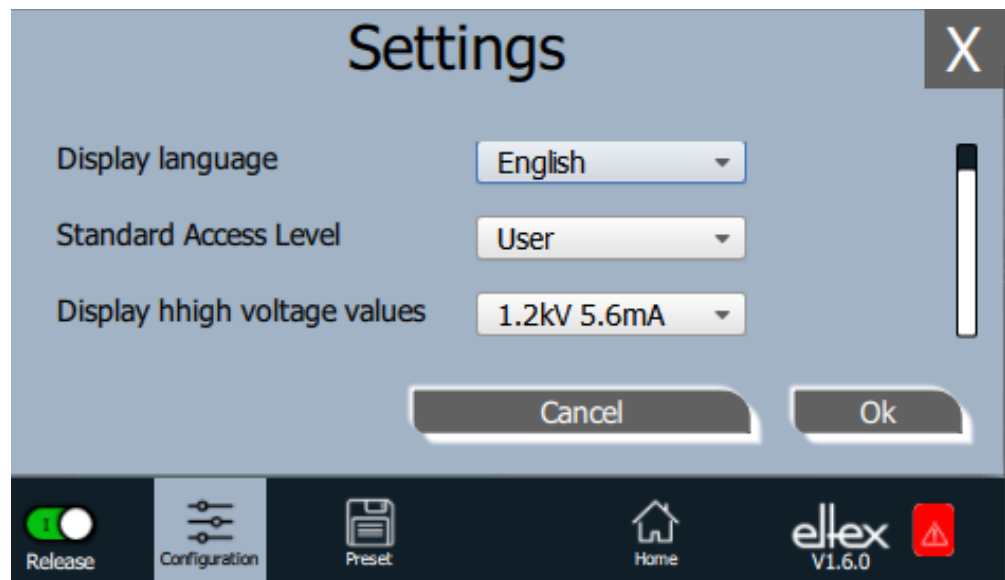

Fig. 34:
Settings

B00442

Select the desired language in the selection list and confirm with OK. If you press the "Cancel" button, changes are not applied and the last valid settings are active.

With the setting of the standard access level, the access level can be configured, which is active when the ECC visualization system is started and when the user logs off.

The voltage and currents values (actual values and parameter values) can be displayed in three different modes:

Example:

- 1.2 kV / 5.6 mA
- 1.23 kV / 5.67 mA
- 1234 V / 5678 μ A

"Release query"

An additional query for setting or deleting the release can be activated with the "Release query".

4.5.2.2.4 Highlight Values

Press the "Highlight Values" button.

Dialog for setting the "Parameters / Status" view.

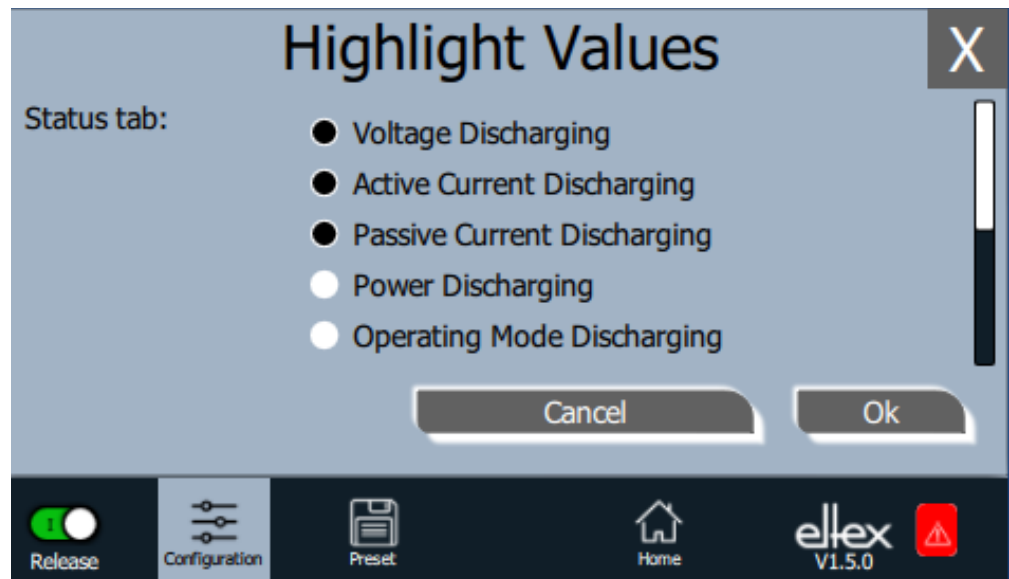

Fig. 35:
Highlight Values

Depending on the access authorization, adjustable actual values are displayed. Select the parameters and confirm with OK. If you press the "Cancel" button, changes are not applied and the last valid settings are active.

4.5.2.2.5 Factory Settings

Press the "Factory Settings" button.

After pressing the "Factory Settings" button (see Chapter. 4.5.2.2), all parameters are loaded into the power supply after a query and their confirmation. After pressing the "Cancel" button, changes are not accepted and the last valid settings are active.

4.5.2.2.6 Login

Press the "Login" button.

After pressing the "Login" button, an input mask opens for entering the user's password. After successful login, the input mask closes automatically.

For detailed information on setting and changing the different user passwords, see Chapter. 4.5.2.2.1.

4.5.2.3 Preset

Press the "Preset" button.

Dialog for loading, saving, editing and deleting presettings of the complete set for quick adjustment of the different values for the respective operation.

The left part of the screen shows the currently saved presets, the right part shows the possible editing options.



Fig. 36:
Preset parameters
overview

Load

The currently selected parameter (e.g. "Preset_0001") is loaded into the parameter set of the power supply after pressing the "Load" button.

New

The current parameter set is saved in the list of presettings under the name to be entered.

Change

Press "Change" for editing the selected preset. All parameters and the file name can be adjusted.

Delete

Press the button to delete the selected preset. After pressing the "Delete" button, the entry is removed from the list of presets.

4.5.2.4 Message overview

Press the "Message overview" button.

Display of currently occurring error and warning messages

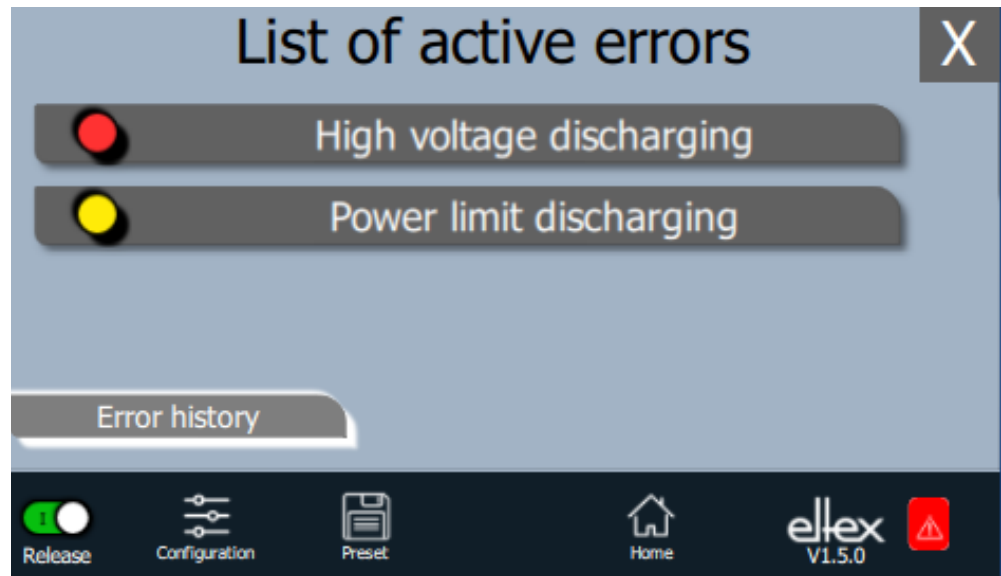

Fig. 37:
Message
overview

After pressing the "Error history" button, a chronological list of all messages that have occurred appears. Click on the respective entry to display further information on the cause of the message and how to resolve it.

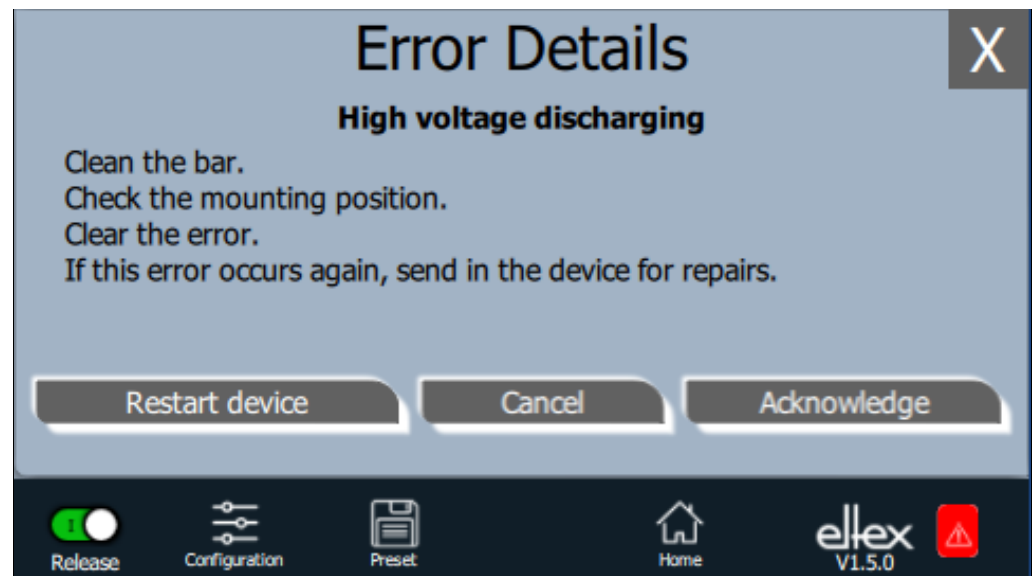

Fig. 38:
Details error
overview

After pressing the "Acknowledge" button, an internal check is carried out; if the check is successful, the message is removed from the list.

In case of messages that cannot be acknowledged, the power supply must be restarted to rectify the error; press the "Restart device" button. Note that "diagnostic messages" cannot be rectified using this function. It is essential to switch the power supply unit off and on again.

4.5.2.5 Parameters

The parameters can be set using the "Parameters" button on the display. To open, press the "Parameters" button in the upper area of the main view. This opens an overview of all parameters that can be read with the current access level. The parameters are arranged according to their function. Depending on the device version, there are up to four sub-items for parameter settings.

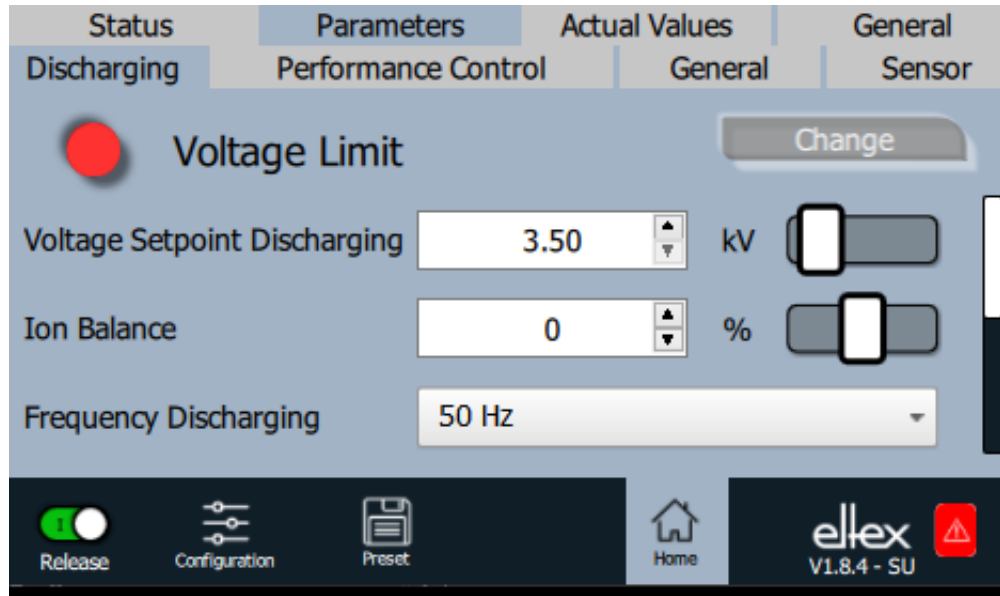

Fig. 39:
Parameters
overview

The parameters can be set by changing the slider on the right-hand side of the corresponding line. After pressing the "Change" button, the new parameter value is transferred and saved.

It is also possible to open another window for setting the parameter by pressing the number in the middle of the line.

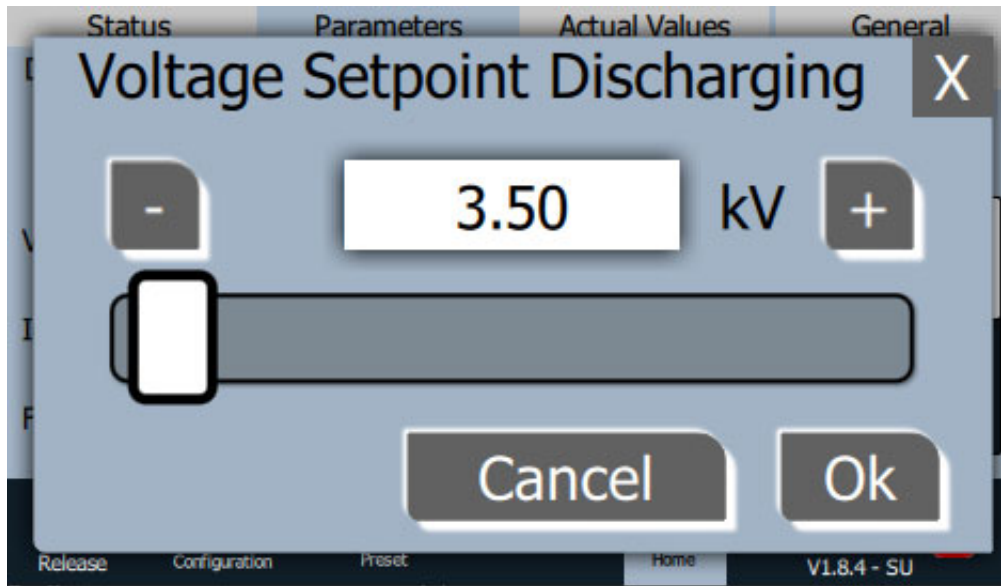

Fig. 40:
Parameters
Setting

B00472

In this window, it is possible to change the parameter value by pressing the plus and minus buttons. The slider can also be used for this purpose. The value is set and saved by pressing the "OK" button.

The selection list for setting the parameters is opened by pressing the displayed parameter value.

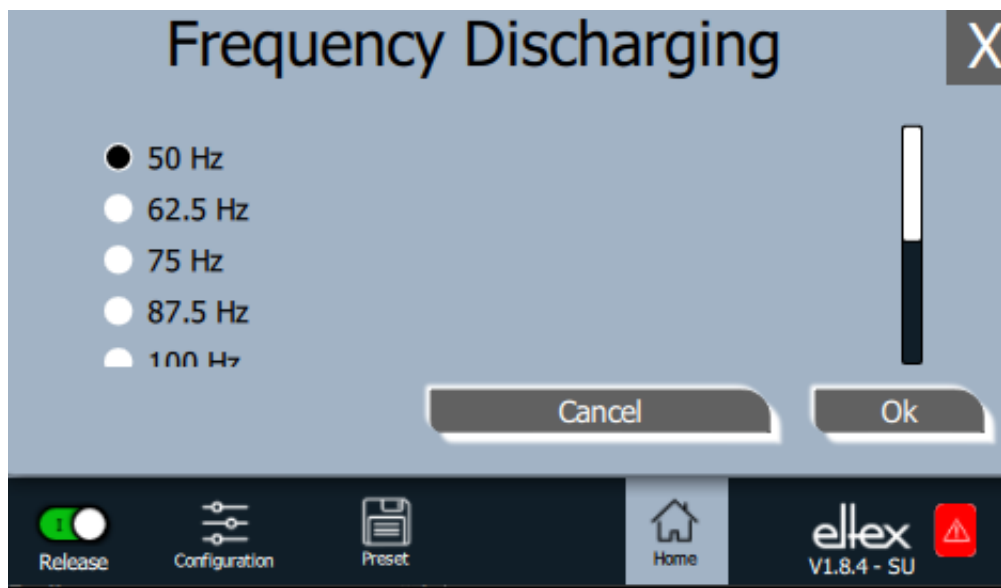

Fig. 41:
Parameters
Selection list

B00473

To set, select the corresponding parameter value in the list and confirm by pressing the "OK" button. The value is then set and saved.

A complete overview of the adjustable parameters with their limits and descriptions can be found in chapter A.3 "Overview Parameters", page 97.

4.5.2.5.1 Discharge Parameters

All parameters required for setting the discharge voltage are summarized in this section. To open this overview, select the "Discharging" sub-item in the parameter overview.

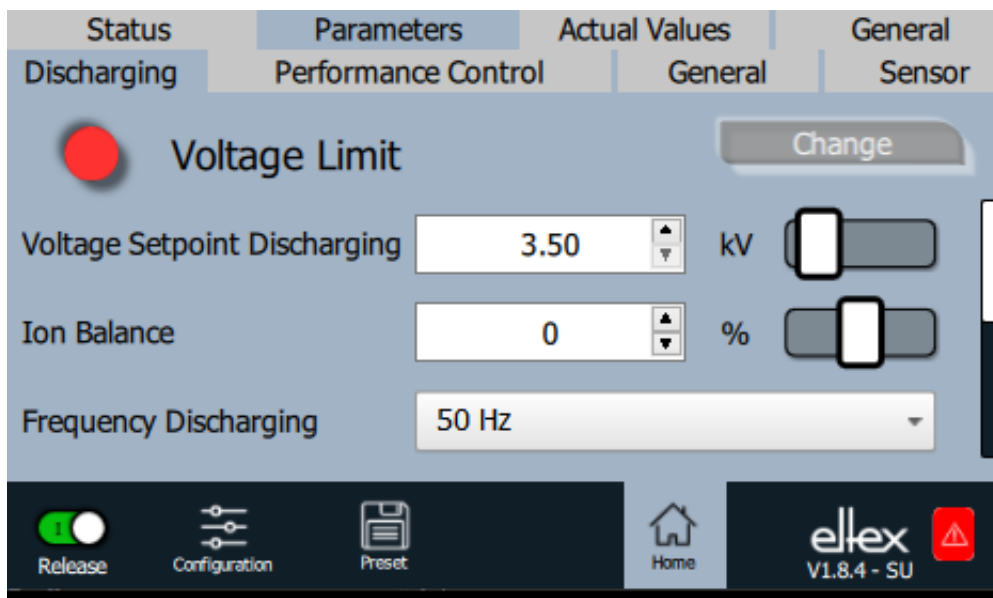

Fig. 42:
Discharge
parameters

The discharge voltage can be adjusted to optimize the discharge result. The discharge voltage and the ion balance can be changed within the defined limits. The frequency of the discharge voltage of the supported settings can also be selected:

It is not possible to change the discharge voltage in the setting for permanent activation of the reference point. In this setting, the parameters for the setpoint, the frequency of the discharge voltage and the ion balance are fixed.

A complete overview of the parameters for setting the discharge can be found in chapter A.3.1 "Parameters Discharge", page 97.

Further information on adjusting the discharge voltage can be found in chapter A.4 "Optimization of the residual charge", page 104.

4.5.2.5.2 Performance Control Parameters

only for variants ES61/P,
see table Pos. 1, chapter 1.4 "Variants", page 10

The parameters available for setting the performance control are summarized in this section. To open this overview, select the "Performance Control" sub-item in the parameter overview. There is a further sub-item for each discharge connection. This lists the parameters required to set the performance control for the selected connection.

All parameters required for setting the discharge voltage are summarized in this item. To open this overview, select the "Discharging" sub-item in the parameter overview.

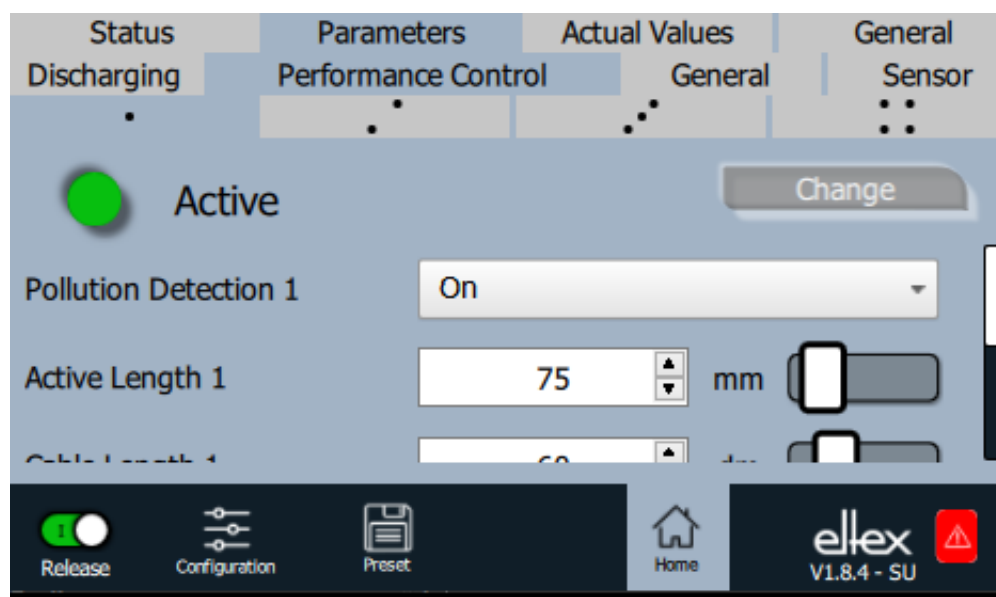

Fig. 43:
Performance
Control
parameters

The Performance Control is used to monitor the connected devices. This must be set individually for each connection for optimum monitoring of the respective device.

The settings must always be made with the high voltage deactivated. The settings should also be adjusted and the calibration carried out again after replacing the connected device. This improves the reliability of the monitoring and increases process stability during operation.

The active length and the cable length of the connected device must be set for the corresponding connection. The warning level for detecting the pollution warning can also be adjusted. This allows the sensitivity of the pollution monitoring to be adjusted.

The setting for activating the reference point is used to select the times and intervals at which the pollution monitoring for the connection is carried out. In principle, this is carried out every time the discharge voltage is switched on.

A detailed description of the function can be found in chapter A.5 "Pollution monitoring", page 106.

A complete overview of the parameters for setting the Performance Control can be found in chapter A.3.2 "Parameters Performance Control", page 98.

4.5.2.5.3 General Parameters

The parameters available for the general setting of the device are listed in this sub-item of the parameter overview. To open this overview, select the "General" sub-item in the parameter overview.

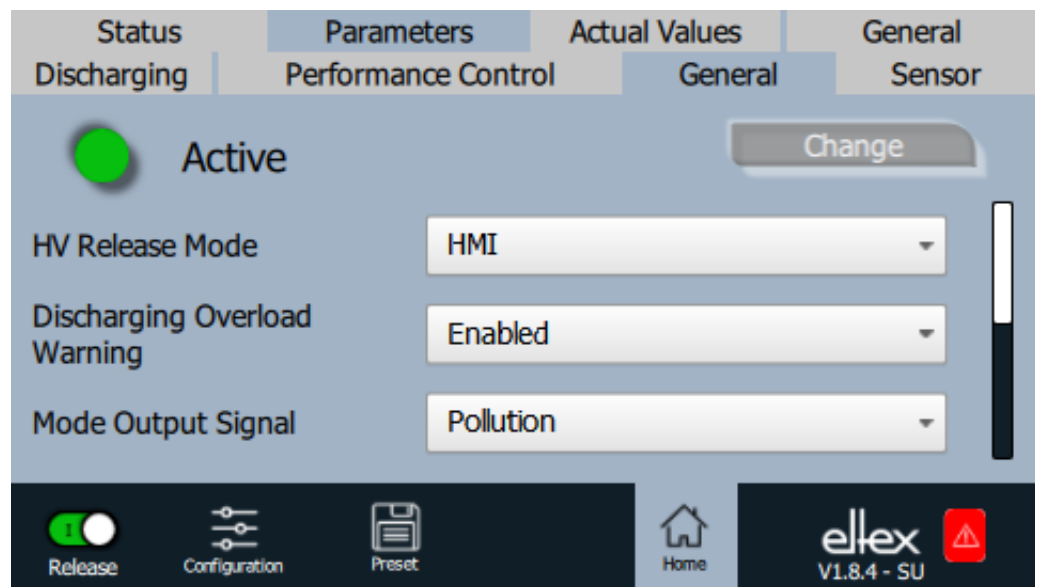

Fig. 44:
General
parameters

Settings for the display mode of the LED bar, the release mode of the discharge voltage and many other general device functions are possible in this area. A complete overview of the parameters for setting the Performance Control can be found in chapter A.3.3 "Parameters General", page 100.

4.5.2.5.4 Sensor Parameter

only for variants ES61/_...C and ES61/_...S,
see table Pos. 6, chapter 1.4 "Variants", page 10

To set the external sensors used via the sensor input, the parameters are available via the "Sensor" button. To open this overview, select the "Sensor" sub-item in the parameter overview.

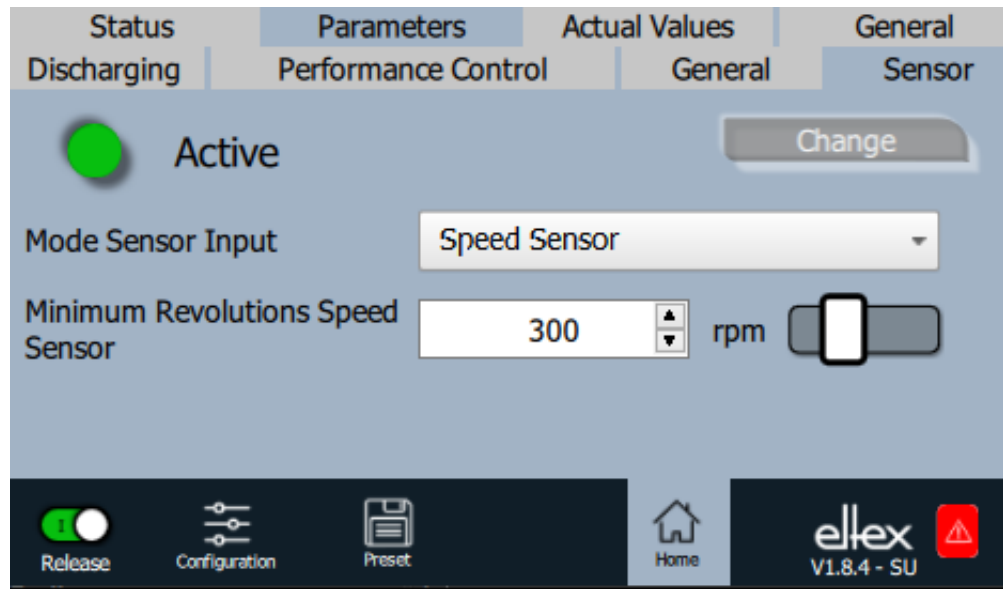

Fig. 45:
Parameters
Speed sensor

Depending on the set mode of the sensor input, the individual parameters for setting are displayed.

Several setting options are available for evaluating the connected sensors. It should be noted that the speed sensors or the specified E-field sensors installed in the rotating nozzles are supported by the evaluation.

Setting the speed sensor

The speed sensor can be used to monitor the function of the corresponding rotating nozzle. If the current speed falls below the set minimum value, the device recognizes the corresponding warning and displays it. This warning only occurs when high voltage is activated and is automatically deleted again when the minimum value is exceeded.

Setting the E-field sensor

A few settings must be made to ensure correct measurement of the connected E-field sensor.

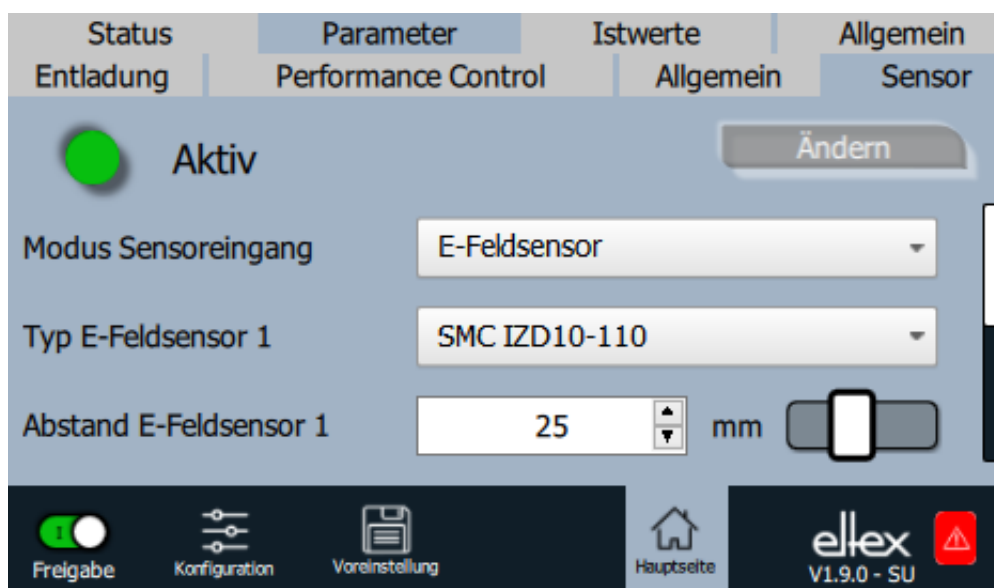

Fig. 46:
Parameters
E-field sensor

First select the appropriate type of sensor. In order to correctly convert the measured electrostatic field into the resulting voltage, the working distance of the sensor must be set.

The zero point deviation of the sensor can also be adjusted. This setting is particularly recommended for applications with high demands on the precision of the measurement. To determine the existing deviation, first set the setting to the value of 0 V. Then mount a grounded metal plate at the working distance of the sensor, read off the current measured value and then set the parameter value.

For process monitoring, it is possible to set an error or warning level for the E-field measured by the sensor. These values must be adjusted for the respective process and are initially set outside the measuring range of the sensor. This basic setting guarantees that no unwanted error or warning messages are generated and that the discharge voltage is deactivated as a result.

Sensor extension setting

The settings for using the sensors connected via the external sensor extension must be made in several steps.

First, select the appropriate mode depending on the configuration of the external sensor extension.

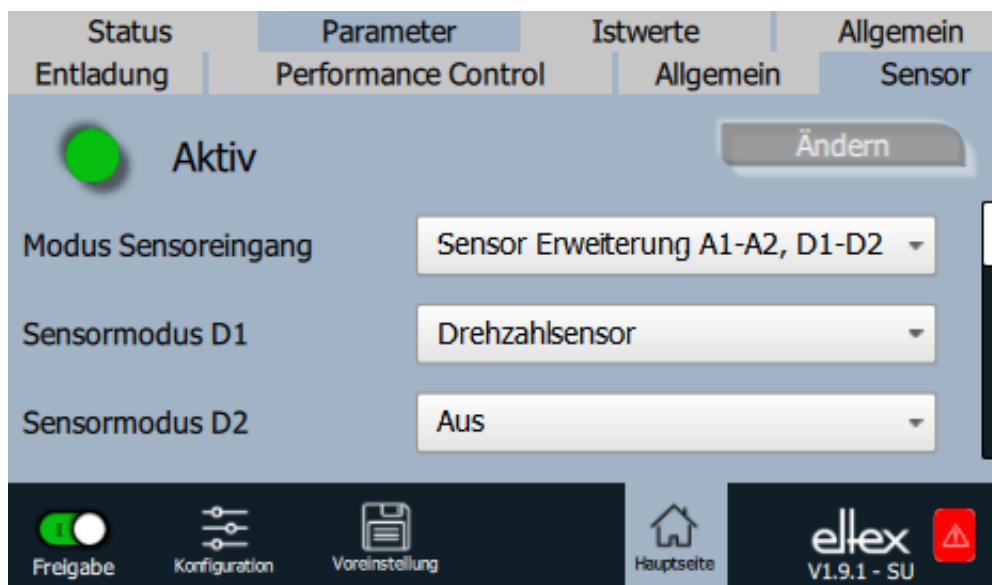

Fig. 47:
Parameters
Sensor extension

The mode for evaluating the connected sensor can then be selected for the available digital and analog sensor inputs.

The parameters for evaluating the speed sensors and E-field sensors are set in the same way as described in “Setting the speed sensor” and “Setting the E-field sensor”.

Depending on the selected mode for the sensor extension and the individual sensor inputs, parameters are displayed or hidden in the list.

A complete overview of the parameters for setting the externally connected sensors can be found in chapter A.3.4 "Parameters Sensor", page 101.

4.5.2.6 Actual values

The current actual values are displayed on the "Actual values" tab in the main view. To open it, press the "Actual values" button at the top of the main view. This opens an overview of all actual values that can be read with the current access level. The actual values are arranged according to their function. Depending on the device version, there are up to four sub-items for displaying the actual values.

A complete overview of the individual values and their description can be found in chapter A.2 "Overview of actual values", page 94.

4.5.2.6.1 Actual values Discharge

Display of the current measured values of the currents, voltages and power of the discharge voltage. To open this overview, select the "Discharging" sub-item in the display of the actual values.

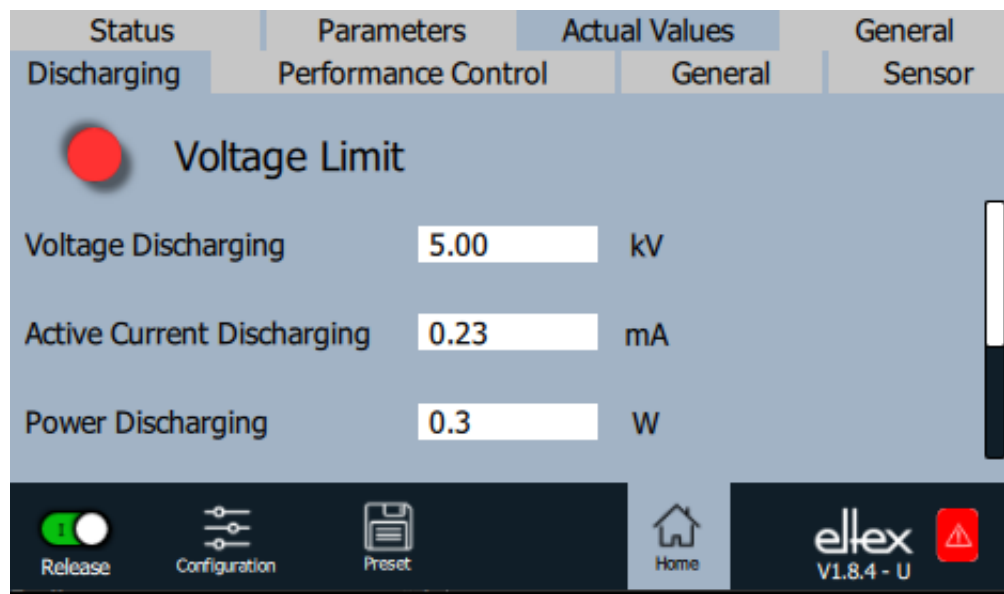

Fig. 48:
Actual values
Discharge

A complete overview of the actual values of the discharging can be found in chapter A.2.1 "Actual values Discharge", page 94.

4.5.2.6.2 Actual values Performance Control

only for variants ES61/P,
see table Pos. 1, chapter 1.4 "Variants", page 10

Display of the actual values for performance control. To open this overview, select the "Performance Control" sub-item in the display of the actual values. There is a further sub-item for each discharge connection. This sub-item then shows the determined pollution and the power of the device as well as the status of the Performance Control.

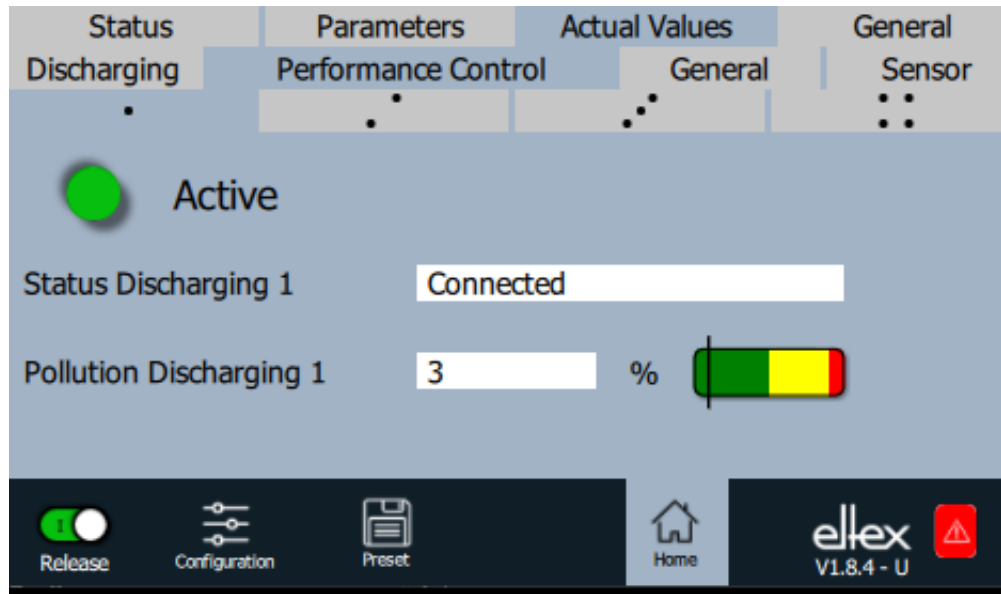

Fig. 49:
Actual values
Performance
Control

A complete overview of the actual values for Performance Control can be found in chapter A.2.2 "Actual values Performance Control", page 95.

B00479

4.5.2.6.3 Actual values General

Display of internal actual values of the supply voltage and device temperature. To open this overview, select the "General" sub-item in the display of actual values.

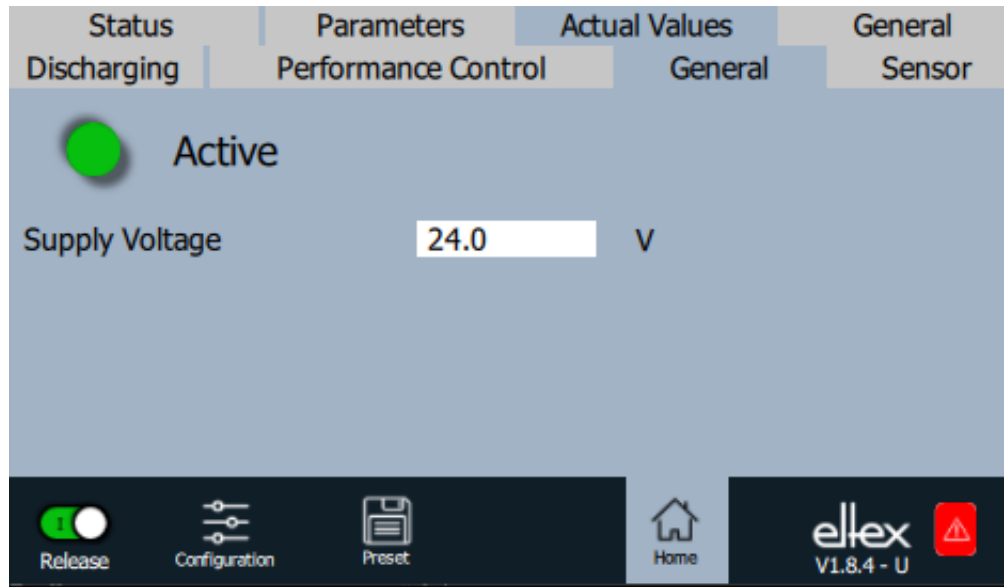

Fig. 50:
Actual values
General

A complete overview of the general actual values can be found in chapter A.2.3 "Actual values General", page 95.

4.5.2.6.4 Actual values Sensor

only for variants ES61/_...C and ES61/_...S,
see table Pos. 6, chapter 1.4 "Variants", page 10

Display of the current measured values of the externally connected sensors. To open this overview, select the "Sensor" sub-item in the display of the actual values.

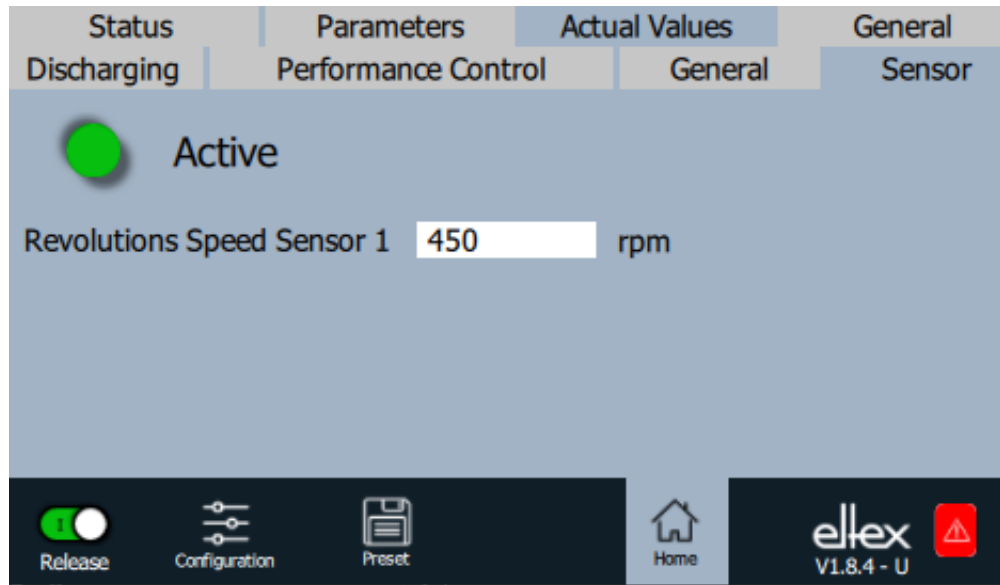

Fig. 51:
Actual values
Sensor

Depending on the set mode of the sensor input, the corresponding actual values are shown in this display.

A complete overview of the actual values of the externally connected sensors can be found in chapter A.2.4 "Actual values Sensor", page 96.

4.5.2.7 General Device Information

Overview of general device information. To open, press the "General" button at the top of the main view. This opens the overview showing the serial number, software versions and operating hours counter.

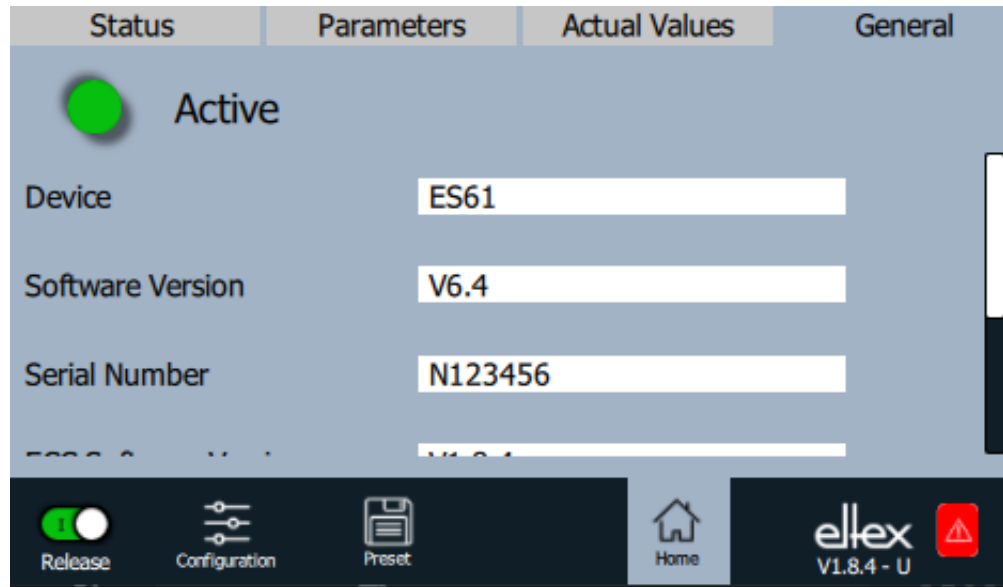

Fig. 52:
General Device
Information

B00482

5. Maintenance



Warning!

Electric shock hazard!

- Switch the power supply off and disconnect the supply voltage before carrying out any maintenance or repair work.
- The machine which has the units fitted must not be in operation.
- Repairs and maintenance work must be carried out by qualified electricians only.



The power supply must be checked regularly to ensure its proper functioning. The connection area of the high voltage cables must be free of dirt and other foreign matter. The intervals for the check depend on the application and must hence be defined by the user according to the operating conditions. The power supply itself does not require any maintenance.

6. Trouble-shooting



Warning!

Electric shock hazard!

- Switch the power supply off and disconnect the supply voltage before carrying out any maintenance or repair work.
- Any work involving the units must be carried out by qualified electricians only.

6.1 Error messages

If an error occurs, the high voltage will be disabled at once and the fault signal output is pulled to 0 V.

Note!

Errors are not saved. The disruption of the supply voltage automatically cancels the malfunction message.

The individual error numbers are listed by number in the following table.

Error number	Error clearable	Cause	Measure
1	No	Initialization failed	<ul style="list-style-type: none"> • Interrupt the supply voltage. • If this error occurs again, send in the device for repairs.
2	No	CPU clock faulty	<ul style="list-style-type: none"> • Interrupt the supply voltage. • If this error occurs again, send in the device for repairs.
3	No	Invalid high voltage configuration	<ul style="list-style-type: none"> • Interrupt the supply voltage. • If this error occurs again, send in the device for repairs.
4	No	Invalid interface configuration	<ul style="list-style-type: none"> • Interrupt the supply voltage. • If this error occurs again, send in the device for repairs.
5	No	Invalid error number	<ul style="list-style-type: none"> • Interrupt the supply voltage. • If this error occurs again, send in the device for repairs.
6	No	Invalid error status	<ul style="list-style-type: none"> • Interrupt the supply voltage. • If this error occurs again, send in the device for repairs.
7	No	Invalid warning number	<ul style="list-style-type: none"> • Interrupt the supply voltage. • If this error occurs again, send in the device for repairs.

Error number	Error clearable	Cause	Measure
8	No	Invalid warning status	<ul style="list-style-type: none"> • Interrupt the supply voltage. • If this error occurs again, send in the device for repairs.
9	No	Invalid lock of the output stages	<ul style="list-style-type: none"> • Interrupt the supply voltage. • If this error occurs again, send in the device for repairs.
10	No	Invalid system status	<ul style="list-style-type: none"> • Interrupt the supply voltage. • If this error occurs again, send in the device for repairs.
11	No	Invalid calibration data	<ul style="list-style-type: none"> • Interrupt the supply voltage. • If this error occurs again, send in the device for repairs.
14	No	Invalid parameter data	<ul style="list-style-type: none"> • Interrupt the supply voltage. • If this error occurs again, send in the device for repairs.
15	No	Invalid operating status	<ul style="list-style-type: none"> • Interrupt the supply voltage. • If this error occurs again, send in the device for repairs.
16	No	Invalid command parameter access	<ul style="list-style-type: none"> • Interrupt the supply voltage. • If this error occurs again, send in the device for repairs.
17	No	Invalid application status	<ul style="list-style-type: none"> • Interrupt the supply voltage. • If this error occurs again, send in the device for repairs.
18	No	Invalid data block	<ul style="list-style-type: none"> • Interrupt the supply voltage. • If this error occurs again, send in the device for repairs.
19	No	Invalid data position	<ul style="list-style-type: none"> • Interrupt the supply voltage. • If this error occurs again, send in the device for repairs.
22	Yes	24 V DC Supply faulty	<ul style="list-style-type: none"> • Check the 24 V DC supply. • Interrupt the supply voltage. • If this error occurs again, send in the device for repairs.

Error number	Error clearable	Cause	Measure
23	Yes	Overcurrent supply voltage	<ul style="list-style-type: none"> • Check the 24 V DC supply. • Clear the error. • If this error occurs again, send in the device for repairs.
35	Yes	Lock of the high voltage has failed	<ul style="list-style-type: none"> • Interrupt the supply voltage. • If this error occurs again, send in the device for repairs.
37	Yes	Invalid release status	<ul style="list-style-type: none"> • Check the release switching of the high voltage. • Clear the error. • If this error occurs again, send in the device for repairs.
42	Yes	General memory error	<ul style="list-style-type: none"> • Clear the error. • If this error occurs again, send in the device for repairs.
43	Yes	Read access memory	<ul style="list-style-type: none"> • Clear the error. • If this error occurs again, send in the device for repairs.
44	Yes	Write access memory	<ul style="list-style-type: none"> • Clear the error. • If this error occurs again, send in the device for repairs.
45	Yes	Invalid parameter address	<ul style="list-style-type: none"> • Interrupt the supply voltage. • If this error occurs again, send in the device for repairs.
49	Yes	LEDs	<ul style="list-style-type: none"> • Clear the error. • If this error occurs again, send in the device for repairs.
51	Yes	Keyboard	<ul style="list-style-type: none"> • Clear the error. • If this error occurs again, send in the device for repairs.
57	Yes	Temperature	<ul style="list-style-type: none"> • Check the installation of the power supply. • Improve the cooling of the housing. • Reduce the ambient temperature. • Reduce the setpoint value. • Clear the error. • If this error occurs again, send in the device for repairs.

Error number	Error clearable	Cause	Measure
58	Yes	High voltage Discharge	<ul style="list-style-type: none"> • Clean the bar. • Check the mounting position. • Reduce the setpoint value. • Clear the error. • If this error occurs again, send in the device for repairs.
59	Yes	Current High voltage Discharge	<ul style="list-style-type: none"> • Clean the bar. • Check the mounting position. • Reduce the setpoint value. • Clear the error. • If this error occurs again, send in the device for repairs.
61	Yes	Power High voltage Discharge	<ul style="list-style-type: none"> • Clean the bar. • Check the mounting position. • Reduce the setpoint value. • Clear the error. • If this error occurs again, send in the device for repairs.
62	Yes	E-field sensor 1	<ul style="list-style-type: none"> • Check external sensor. • Check the settings. • Clean the bar. • Check the mounting position. • Clear the error. • If this error occurs again, send in the device for repairs.
63	Yes	E-field sensor 2	<ul style="list-style-type: none"> • Check external sensor. • Check the settings. • Clean the bar. • Check the mounting position. • Clear the error. • If this error occurs again, send in the device for repairs.
64	Yes	Pollution Discharge 1	<ul style="list-style-type: none"> • Clean the bar. • Check the mounting position. • Clear the error. • If this error occurs again, send in the device for repairs.

Error number	Error clearable	Cause	Measure
65	Yes	Pollution Discharge 2	<ul style="list-style-type: none"> • Clean the bar. • Check the mounting position. • Clear the error. • If this error occurs again, send in the device for repairs.
66	Yes	Pollution Discharge 3	<ul style="list-style-type: none"> • Clean the bar. • Check the mounting position. • Clear the error. • If this error occurs again, send in the device for repairs.
67	Yes	Pollution Discharge 4	<ul style="list-style-type: none"> • Clean the bar. • Check the mounting position. • Clear the error. • If this error occurs again, send in the device for repairs.
68	Yes	Connection Discharge 1	<ul style="list-style-type: none"> • Check high voltage cables and connections. • Clean the bar. • Clear the error. • If this error occurs again, send in the device for repairs.
69	Yes	Connection Discharge 2	<ul style="list-style-type: none"> • Check high voltage cables and connections. • Clean the bar. • Clear the error. • If this error occurs again, send in the device for repairs.
70	Yes	Connection Discharge 3	<ul style="list-style-type: none"> • Check high voltage cables and connections. • Clean the bar. • Clear the error. • If this error occurs again, send in the device for repairs.
71	Yes	Connection Discharge 4	<ul style="list-style-type: none"> • Check high voltage cables and connections. • Clean the bar. • Clear the error. • If this error occurs again, send in the device for repairs.

Error number	Error clearable	Cause	Measure
73	Yes	General error ethernet modul	<ul style="list-style-type: none"> • Check the bus line. • Check the communication with the control. • Clear the error. • If this error occurs again, send in the device for repairs.
74	Yes	Communication error Ethernet modul	<ul style="list-style-type: none"> • Check the bus line. • Check the communication with the control. • Clear the error. • If this error occurs again, send in the device for repairs.
76	Yes	Invalid operating mode Ethernet modul	<ul style="list-style-type: none"> • Check the bus line • Check the communication with the control. • Clear the error. • If this error occurs again, send in the device for repairs.

6.2 Warning messages

If a warning message appears, the output of the high voltage is not blocked.

Note!

Warnings are not saved. The disruption of the supply voltage automatically cancels the warning message.

The individual error numbers are listed by number in the following table.

Warning number	Cause	Measure
1	Error cannot be cleared.	<ul style="list-style-type: none"> • Interrupt the supply voltage. • If this error occurs again, send in the device for repairs.
2	Clearable error has not occurred.	<ul style="list-style-type: none"> • Clear the warning.
3	Error counter has an invalid value.	<ul style="list-style-type: none"> • Clear the warning.
4	The release of the output stage has been disabled.	<ul style="list-style-type: none"> • An error occurred during the release of the high voltage. • Do not send the release telegram again. • First eliminate the cause of the error, then clear the warning.

Warning number	Cause	Measure
26	Temperature	<ul style="list-style-type: none"> • Check the installation of the power supply. • Improve the cooling of the housing. • Reduce the ambient temperature. • Reduce the setpoint value.
27	Voltage limit Discharge	<ul style="list-style-type: none"> • Clean the bar. • Check the mounting position.
28	Current limit Discharge	<ul style="list-style-type: none"> • Clean the bar. • Check the mounting position.
29	Power limit Discharge	<ul style="list-style-type: none"> • Clean the bar. • Check the mounting position. • Reduce the setpoint value. • Reduce the power input. • Reduce the discharge frequency.
35	Pollution calibration	<ul style="list-style-type: none"> • Clean the bar. • Check the mounting position. • Clear the warning.
36	Pollution Discharge 1	<ul style="list-style-type: none"> • Clean the bar. • Check the mounting position. • Clear the warning.
37	Pollution Discharge 2	<ul style="list-style-type: none"> • Clean the bar. • Check the mounting position. • Clear the warning.
38	Pollution Discharge 3	<ul style="list-style-type: none"> • Clean the bar. • Check the mounting position. • Clear the warning.
39	Pollution Discharge 4	<ul style="list-style-type: none"> • Clean the bar. • Check the mounting position. • Clear the warning.
40	Overload Discharge 1	<ul style="list-style-type: none"> • Check high voltage cables and connections. • Clean the bar. • Clear the error. • Reduce the connected load.
41	Overload Discharge 2	<ul style="list-style-type: none"> • Check high voltage cables and connections. • Clean the bar. • Clear the error. • Reduce the connected load.

Warning number	Cause	Measure
42	Overload Discharge 3	<ul style="list-style-type: none"> • Check high voltage cables and connections. • Clean the bar. • Clear the error. • Reduce the connected load.
43	Overload Discharge 4	<ul style="list-style-type: none"> • Check high voltage cables and connections. • Clean the bar. • Clear the error. • Reduce the connected load.
44	Speed sensor 1	<ul style="list-style-type: none"> • Check external sensor. • Check the mounting position. • Clear the warning.
45	Speed sensor 2	<ul style="list-style-type: none"> • Check external sensor. • Check the mounting position. • Clear the warning.
46	Speed sensor 3	<ul style="list-style-type: none"> • Check external sensor. • Check the mounting position. • Clear the warning.
47	Speed sensor 4	<ul style="list-style-type: none"> • Check external sensor. • Check the mounting position. • Clear the warning.
48	Speed sensor 5	<ul style="list-style-type: none"> • Check external sensor. • Check the mounting position. • Clear the warning.
49	Speed sensor 6	<ul style="list-style-type: none"> • Check external sensor. • Check the mounting position. • Clear the warning.
50	Speed sensor 7	<ul style="list-style-type: none"> • Check external sensor. • Check the mounting position. • Clear the warning.
51	Speed sensor 8	<ul style="list-style-type: none"> • Check external sensor. • Check the mounting position. • Clear the warning.
52	Speed sensor 9	<ul style="list-style-type: none"> • Check external sensor. • Check the mounting position. • Clear the warning.

Warning number	Cause	Measure
53	Speed sensor 10	<ul style="list-style-type: none"> • Check external sensor. • Check the mounting position. • Clear the warning.
54	Analog sensor input 1	<ul style="list-style-type: none"> • Check external sensor. • Check the settings. • Clear the warning.
55	Analog sensor input 2	<ul style="list-style-type: none"> • Check external sensor. • Check the settings. • Clear the warning.
56	E-field sensor 1	<ul style="list-style-type: none"> • Check external sensor. • Check the settings. • Clean the bar. • Check the mounting position. • Clear the warning.
57	E-field sensor 2	<ul style="list-style-type: none"> • Check external sensor. • Check the settings. • Clean the bar. • Check the mounting position. • Clear the warning.
58	Sensor extension Communication	<ul style="list-style-type: none"> • Check external sensor extension. • Check 24 V DC. • Clear the warning.
64	CAN communication error	<ul style="list-style-type: none"> • Check bus cabling. • Check the set baud rate. • Clear the warning. • If this warning occurs again, send in the device for repairs.
65	General CANopen® communication error	<ul style="list-style-type: none"> • Check bus cabling. • Check CANopen® transmission. • Clear the warning. • If this warning occurs again, send in the device for repairs.
66	CANopen® SDO access	<ul style="list-style-type: none"> • Check SDO transmission protocol. • Clear the warning. • If this warning occurs again, send in the device for repairs.

Warning number	Cause	Measure
67	CANopen® PDO access	<ul style="list-style-type: none"> • Check PDO transmission protocol. • Compare PDO access with the EDS file. • Clear the warning. • If this error occurs again, send in the device for repairs.
68	CANopen® PDO data length incorrected	<ul style="list-style-type: none"> • Check PDO transmission protocol. • Clear the warning. • If this warning occurs again, send in the device for repairs.
69	CANopen® buffer overflow	<ul style="list-style-type: none"> • Bus load is too high. • Too many CAN messages have been sent. • Clear the warning. • If this warning occurs again, send in the device for repairs.
70	CANopen® error field Transmission error	<ul style="list-style-type: none"> • Clear the warning. • If this warning occurs again, send in the device for repairs.
71	CANopen® node monitoring error	<ul style="list-style-type: none"> • Check node monitoring of the CANopen® master. • Clear the warning. • If this warning occurs again, send in the device for repairs.
72	Error when reconnecting	<ul style="list-style-type: none"> • Check bus cabling. • Check the set baud rate. • Clear the warning. • If this warning occurs again, send in the device for repairs.
81	Parameter value below minimum	<ul style="list-style-type: none"> • Parameter was automatically corrected to minimum. • Clear the warning.
82	Parameter value above maximum	<ul style="list-style-type: none"> • Parameter was automatically corrected to maximum. • Clear the warning.
84	Invalid parameter value	<ul style="list-style-type: none"> • Parameter was not changed. Transmit correct value. • Clear the warning.

7. Technical specifications ES61

Input		
	ES61/_A	ES61/_D
Supply voltage	90 - 264 V AC, 47 - 63 Hz	24 V DC \pm 15 %
	The voltage must not exceed 60 V at the input plugs of the 24 V DC supply voltage, the analog interfaces of the discharge and the field bus interfaces.	
Power consumption	max. 50 Watt	
Inrush current	max. 75 A	---
Recommended Tripping characteristics according to DIN EN 60947-2	2 A/C	4 A/C
Fuse (primary circuit)	see type plate	
Mains connection cable	depending on the device variant, either with grounding contact plug (approx. 2.5 m) or with free end (cable length max. 99 m) or pluggable	
Connectivity		
Operation	optional: membrane keyboard or display	
Interfaces	CANopen®, supported baud rates: 10 kBit/s, 20 kBit/s, 50 kBit/s, 125 kBit/s, 250 kBit/s, 500 kBit/s, 800 kBit/s, 1000 kBit/s ModbusTCP, supported transmission speeds: 10 / 100 MBit/s	
I/O interface	24 V DC input for high voltage release Fault signal output: max. 24 V DC \pm 20 % / 50 mA internal protection Signal output: max. 24 V DC \pm 20 % / 50 mA) internal protection	
Sensor input	24 V DC output: max. 24 V DC \pm 20 % / 50 mA) internal protection analog sensor input: 0 - 10 V digital sensor input: 0 - 24 V with the power supply unit switched off and high voltage generation deactivated	

Output	
Voltage	3.5 - 5 KV AC
Current	max. 6.2 mA
Frequency	50 - 200 Hz
Connections	4, adjustable in stages
Load capacity	depending on bar type and bar length and high voltage cable length (see Chapter 3.3.1)
Features	
Ion balance	Ion balance adjustable between 0 - 15 % of the set target value of the discharge voltage. Setting possible for both positive and negative polarity.
Performance Control (optional)	Connections monitored separately detection of the device, the pollution and the overload
Passive operating mode	when the power supply unit switched off or the high voltage is deactivated
Key data	
Housing type	sheet metal steel with wall bracket
Operating ambient temperature	+5...+50 °C (+41...+122°F)
Storage temperature	-20...+80 °C (-4...+176 °F)
Ambient humidity	max. 80 % r. h. , non-condensing
Protection classe	IP54 according EN 60529
Housing dimensions	240 x 180 x 100 (L x W x H)
Weight	approx. 4.1 kg



8. Dimensions

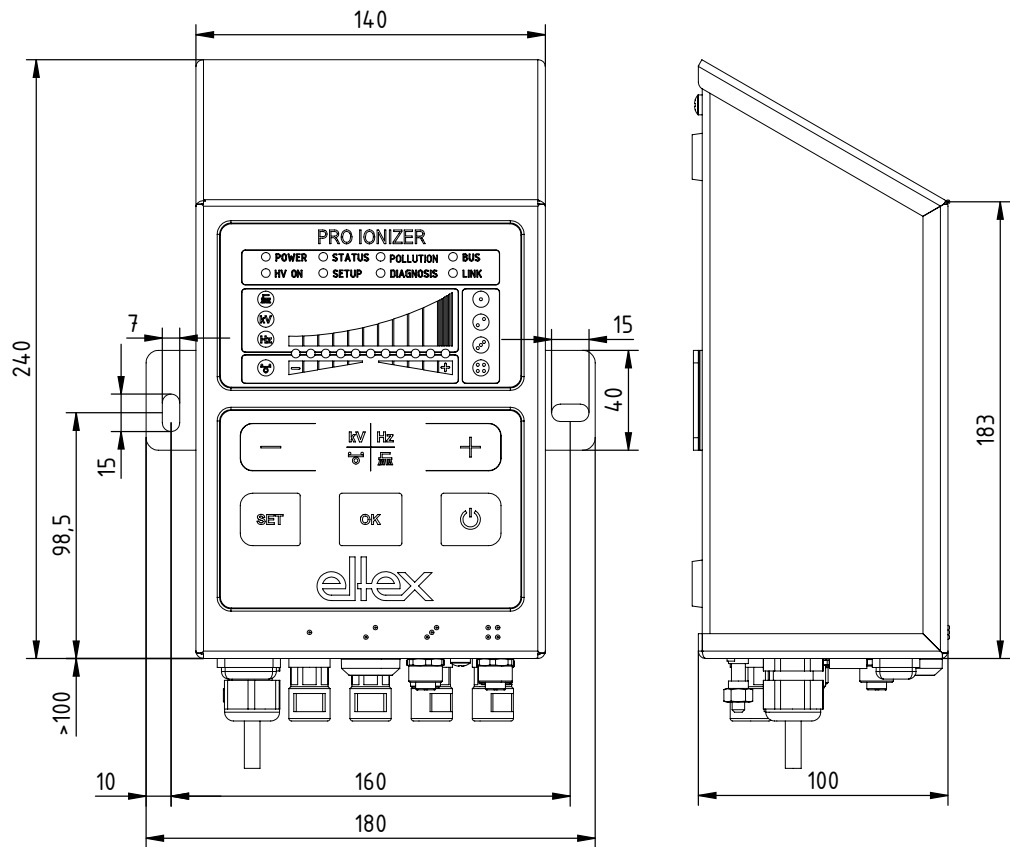

Fig. 53:
Dimensions
Power Supply with
fixing positions

Assembly with 2 x hexagon screws M5 (alternatively M6) including flat washer

Z-118404y_3

9. Spare parts and accessories

Article	Article-No.
High voltage distributor Discharge, 4 terminals (1 high voltage cable, 4 outputs) Specify plug and socket types as well as cable length	ESV61/_ _ _ _ _
High voltage distributor Discharge, 2 terminals (1 high voltage cable, 2 outputs) Specify plug and socket types as well as cable length	ESVY61/_ _ _ _ _
Extension cable	KE/_ B
Mains cable 24 V DC Specify customer-side connection and cable length	KN/H_ _ _ _ _
Plug M16 for 24 V DC supply voltage, confectionable	116136
Interface cable: I/O interface open cable ends on consumer side (specify cable length)	CS/EMO_ _ _ _
Plug M12, 5-pin for I/O interface	116138
Field bus CANopen® interface cable, female, plug / socket on customer side, straight / angled or open cable ends selectable (specify cable length)	CS/CM_ _ _ _ _
Interface cable Field bus CANopen®, female, on customer side Plug / Socket, straight / angled or open cable ends selectable (specify cable length)	CS/CF_ _ _ _ _
T-distributor M12, 5-pin, shielded	114854
Adapter D-Sub socket, M12 plug	114858
Field bus Industrial Ethernet interface cable, male, plug on customer side, straight / angled or open cable ends selectable (specify cable length)	CS/IM_ _ _ _ _
Field bus Industrial Ethernet interface cable, male, RJ45 on customer side (specify cable length, max. 10 m)	CS/IMR_ _ _ _
Protective cap M12 plug	108448
Protective cap Service interface	116121
Protective cap M12 socket	108449
Protective cap M16 plug	ELM01115
CANopen® terminating plug	114855
Terminating box CANopen®	117550
Microfuse AC version	113522
Microfuse DC version	ELM00048
E-field sensor IZD 10-110 (measuring range +/- 0.4 kV)	114944
E-field sensor IZD 10-510 (measuring range +/- 20 kV)	118599
Volt Stick	109136
Operating Instructions (specify language)	BA-xx-2085

Please specify the article number when ordering.

10. Waste disposal

The ES61 power supply unit can be disposed of using the general waste disposal methods (electronic waste).

A. ANNEX

A.1 Assembly of the plugs

A.1.1 Plug M16 for 24 V DC supply voltage straight version, version with shield clamping ring

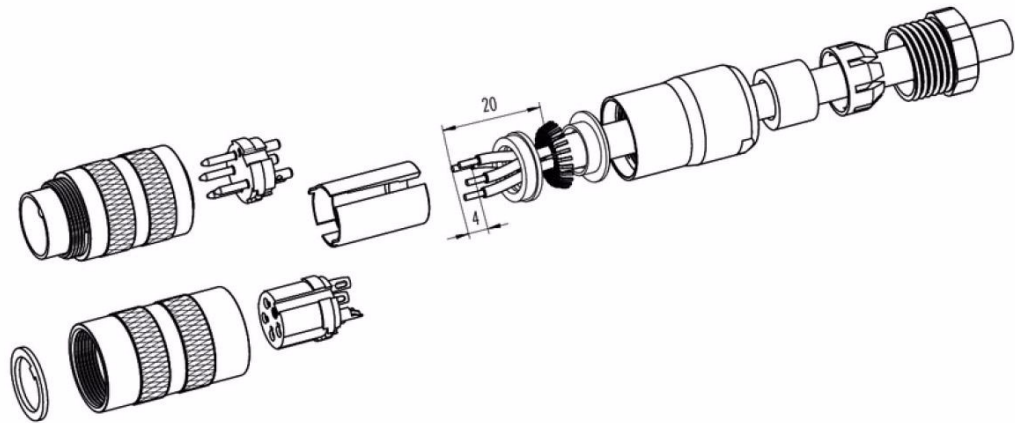

Fig. 54:
Plug M16
for 24 V DC
power supply

1. Bead the pressure screw, pinch ring, seal, distance shell onto the first shield clamping ring.
2. Strip wires, widen shield and bead second shield clamping ring.
3. Solder wires, snap distance shell, push the two shield clamping rings together and cut off projecting shielding braid.
4. Assemble remaining parts according to figure.

Z-116136y

A.1.2 Plug M12, 4 or 5-pin for I/O interface and sensor input

A = 5 mm

Schirmdurchmesser >5,5 mm
shielding braid diameter >5,5 mm

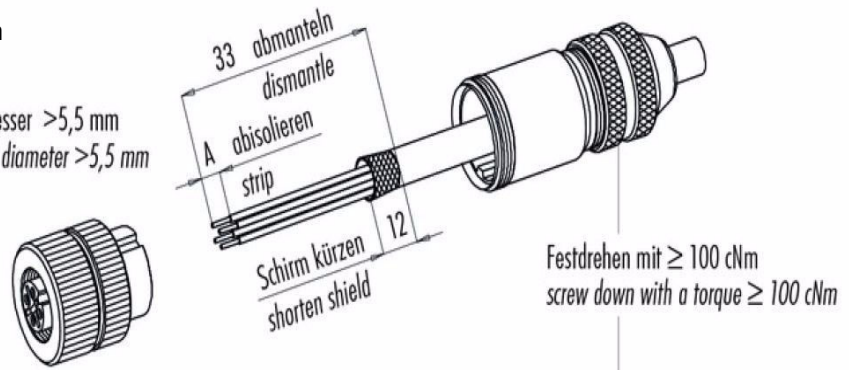

Schirmdurchmesser ≤5,5 mm
shielding braid diameter ≤5,5 mm

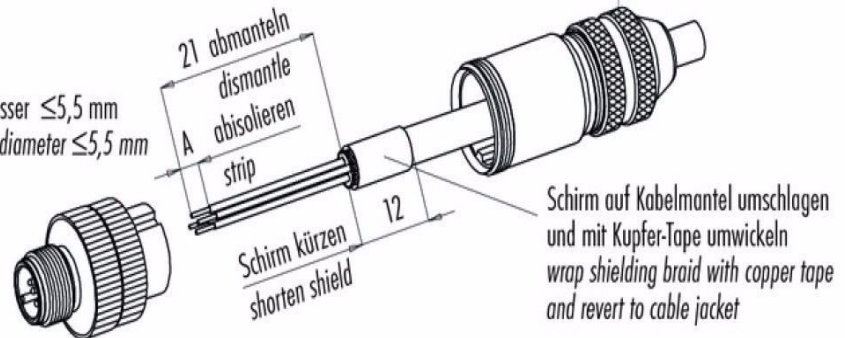

Fig. 55:
Plug M12,
4 or 5-pin
for I/O interface
and sensor input

Z-116137y

A.2 Overview of actual values

A.2.1 Actual values Discharge

Function	Description	Standard access level
Voltage Discharge	Effective value (RMS) of the sinusoidal output voltage of the discharge	Viewer
Positive voltage	Effective value (RMS) of the positive sinusoidal output voltage of the discharge	Super User
Negative voltage	Effective value (RMS) of the negative sinusoidal output voltage of the discharge	Super User
Active current Discharge	Effective value (RMS) of the active sinusoidal alternating current of the discharge	User
Passive current Discharge	Average value of the passiv eDC current of the discharge	Super User
Power Discharge	Discharge output power	Viewer
Operating status Discharge	Current operating status of the discharge with display of the mode and possibly active limiter	User
Capacity Discharge	High voltage capacity of the discharge in percentage	Viewer

A.2.2 Actual values Performance Control

only for variants ES61/P,
see table Pos. 1, chapter 1.4 "Variants", page 10

Function	Description	Standard access level
Status Discharge 1	Discharge status Connection 1	User
Pollution Discharge 1	Detected pollution Discharge Connection 1	User
Power Discharge 1	Effective power Discharge Connection 1	Super User
Status Discharge 2	Discharge status Connection 2	User
Pollution Discharge 2	Detected pollution Discharge Connection 2	User
Power Discharge 2	Effective power Discharge Connection 2	Super User
Status Discharge 3	Discharge status Connection 3	User
Pollution Discharge 3	Detected pollution Discharge Connection 3	User
Power Discharge 3	Effective power Discharge Connection 3	Super User
Status Discharge 4	Discharge status Connection 4	User
Pollution Discharge 4	Detected pollution Discharge Connection 4	User
Power Discharge 4	Effective power Discharge Connection 4	Super User

A.2.3 Actual values General

Function	Description	Standard access level
Supply voltage	Voltage of the internal supply voltage	User
Temperature Device	Internal device temperature	Super User

A.2.4 Actual values Sensor

only for variants ES61/_...C and ES61/_...S,
see table Pos. 6, chapter 1.4 "Variants", page 10

Function	Description	Standard access level
Revolutions Speed sensor 1	Current number of revolutions of the external speed sensor 1	User
Revolutions Speed sensor 2	Current number of revolutions of the external speed sensor 2	User
Revolutions Speed sensor 3	Current number of revolutions of the external speed sensor 3	User
Revolutions Speed sensor 4	Current number of revolutions of the external speed sensor 4	User
Revolutions Speed sensor 5	Current number of revolutions of the external speed sensor 5	User
Revolutions Speed sensor 6	Current number of revolutions of the external speed sensor 6	User
Revolutions Speed sensor 7	Current number of revolutions of the external speed sensor 7	User
Revolutions Speed sensor 8	Current number of revolutions of the external speed sensor 8	User
Revolutions Speed sensor 9	Current number of revolutions of the external speed sensor 9	User
Revolutions Speed sensor 1	Current number of revolutions of the external speed sensor 10	User
E-field sensor 1	Current measured value of the external E-field sensor 1	User
E-field sensor 2	Current measured value of the external E-field sensor 2	User

A.3 Overview Parameters

A.3.1 Parameters Discharge

Function	Description	Standard access level	Range	Factory setting
Voltage Setpoint Discharge	Setting of the high voltage setpoint, Discharge	Viewer (read) User (write)	3,500 V - 5,000 V	4,600 V
Ion balance	Discharge optimization of the balance setting of positive and negative ions	Viewer (read) User (write)	-100 - 100 %	0 %
Activation Reference point	Setting to activate the reference point for executing the Performance Control, Discharge	User (read, write)	High voltage release Permanent Cyclical 1 minute Cyclical 10 minutes Cyclical 30 minutes Cyclical 60 minutes Field bus enquiry	High voltage release
Frequency Discharge	Setting of the high voltage frequency, Discharge	Viewer (read) User (write)	50 Hz, 62,5 Hz, 75 Hz, 87,5 Hz, 100 Hz, 125 Hz, 150 Hz, 175 Hz, 200 Hz	50 Hz
Operating mode Discharge	Selection of the operating status, Discharge	Super user (read, write)	passive discharge, active discharge	active discharge

A.3.2 Parameters Performance Control

only for variant ES61/P

see table Pos. 1, chapter 1.4 "Variants", page 10

Function	Description	Standard access level	Range	Factory setting
Pollution detection 1	Setting of the pollution monitoring Discharge, connection 1	User (read) Super user (write)	OFF ON Calibracion	OFF
Active length 1	Indication of the connected active length Discharge, connection 1	User (read) Super user (write)	0 - 6,000 mm	0 mm
Cable length 1	Indication of the connected cable length Discharge, connection 1	User (read) Super user (write)	0 - 350 dm	0 dm
Warning level 1	Setting the warning level for pollution monitoring Discharge, connection 1	User (read, write)	20 - 90 %	50 %
Pollution detection 2	Setting of the pollution monitoring Discharge, connection 2	User (read) Super user (write)	OFF ON Calibracion	OFF
Active length 2	Indication of the connected active length Discharge, connection 2	User (read) Super user (write)	0 - 6,000 mm	0 mm
Cable length 2	Indication of the connected cable length Discharge, connection 2	User (read) Super user (write)	0 - 350 dm	0 dm
Warning level 2	Setting the warning level for pollution monitoring Discharge, connection 2	User (read, write)	20 - 90 %	50 %
Pollution detection 3	Setting of the pollution monitoring Discharge, connection 3	User (read) Super user (write)	OFF ON Calibracion	OFF
Active length 3	Indication of the connected active length Discharge, connection 3	User (read) Super user (write)	0 - 6,000 mm	0 mm
Cable length 3	Indication of the connected cable length Discharge, connection 3	User (read) Super user (write)	0 - 350 dm	0 dm

Warning level 3	Setting the warning level for pollution monitoring Discharge, connection 3	User (read, write)	20 - 90 %	50 %
Pollution detection 4	Setting of the pollution monitoring Discharge, connection 4	User (read) Super user (write)	OFF ON Calibracion	OFF
Active length 4	Indication of the connected active length Discharge, connection 4	User (read) Super user (write)	0 - 6,000 mm	0 mm
Cable length 4	Indication of the connected cable length Discharge, connection 4	User (read) Super user (write)	0 - 350 dm	0 dm
Warning level 4	Setting the warning level for pollution monitoring Discharge, connection 4	User (read, write)	20 - 90 %	50 %
Activation Reference point	Setting to activate the reference point for executing the Performance Control, Discharge	User (read, write)	High voltage release Permanent Cyclical 1 minute Cyclical 10 minutes Cyclical 30 minutes Cyclical 60 minutes Field bus enquiry	High voltage release

A.3.3 Parameters General

Depending on the variant, the specifications for the setting range and the factory settings of the respective parameter may differ. The information refers to a variant with the maximum possible equipment.

Function	Description	Standard access level	Range	Factory setting
High voltage release mode	Release mode of the high voltage	Super user (read, write)	Autostart HMI Field bus HMI + Field bus Hardware release Hardware release + HMI Hardware release + Field bus Hardware release + HMI + Field bus	HMI
Discharge overload warning	Setting of the overload Discharge warning message	Super user (read, write)	Deactivated Activated	Activated
Message output mode	Setting the mode of the signal output I/O interface	Super user (read, write)	High voltage active Warning Pollution	High voltage active
LED Bar Mode	Switching the view of the LED bar of the power supply	User (read, write)	Voltage Frequency Balance Pollution Pollution Discharge 1 Pollution Discharge 2 Pollution Discharge 3 Pollution Discharge 4	Voltage
CANopen® node address	Adjustment of the CANopen® node adresse for the	Super user (read, write)	1 - 126	99
CANopen® baud rate	Adjustment of the CANopen® baud rate for the device	Super user (read, write)	OFF 10 kBit/s, 25 kBit/s, 50 kBit/s, 125 kBit/s, 250 kBit/s, 500 kBit/s, 800 kBit/s, 1000 kBit/s	125 kBit/s

A.3.4 Parameters Sensor

only for variants ES61/_C and ES61/_S,
see table Pos. 6, chapter 1.4 "Variants", page 10

Function	Description	Standard access level	Range	Factory setting
Sensor input mode	Setting the sensor input mode	User (read) Super user (write)	OFF Speed sensor E-field sensor Sensor extension A1-A2, D1-D2 Sensor extension A1-A2, D1-D6 Sensor extension A1-A2, D1-D10	OFF
Sensor mode D1	Mode selection for the external sensor input D1	User (read) Super user (write)	OFF Speed sensor	OFF
Sensor mode D2	Mode selection for the external sensor input D2	User (read) Super user (write)	OFF Speed sensor	OFF
Sensor mode D3	Mode selection for the external sensor input D3	User (read) Super user (write)	OFF Speed sensor	OFF
Sensor mode D4	Mode selection for the external sensor input D4	User (read) Super user (write)	OFF Speed sensor	OFF
Sensor mode D5	Mode selection for the external sensor input D5	User (read) Super user (write)	OFF Speed sensor	OFF
Sensor mode D6	Mode selection for the external sensor input D1	User (read) Super user (write)	OFF Speed sensor	OFF
Sensor mode D7	Mode selection for the external sensor input D7	User (read) Super user (write)	OFF Speed sensor	OFF
Sensor mode D8	Mode selection for the external sensor input D8	User (read) Super user (write)	OFF Speed sensor	OFF

Sensor mode D9	Mode selection for the external sensor input D9	User (read) Super user (write)	OFF Speed sensor	OFF
Sensor mode D10	Mode selection for the external sensor input D10	User (read) Super user (write)	OFF Speed sensor	OFF
Minimum rotational speed	Setting the monitored minimum rotational speed of the speed sensors	User (read) Super user (write)	0 - 1.200 rpm	300 rpm
Sensor mode A1	Mode selection for the external sensor input A1	User (read) Super user (write)	OFF E-field-sensor	OFF
Type E-field sensor 1	Selection of the connected E-field sensors 1	User (read) Super user (write)	SMC IZD 10-110. SMC IZD 10-510	SMC IZD 10-110
Distance E-field sensor 1	Setting the distance for converting the E-field 1	User (read) Super user (write)	10 mm - 50 mm (SMC IZD 10-110) 25 mm - 75 mm (SMC IZD 10-510)	25 mm
Warning level E-field sensor 1	Setting for warning detection when measured value is exceeded 1	User (read) Super user (write)	0 V - 1,000 V (SMC IZD 10-110) 0 V - 30,000 V (SMC IZD 10-510)	800 V
Error level E-field sensor 1	Setting for error detection when measured value is exceeded 1	User (read) Super user (write)	0 V - 1,000 V (SMC IZD 10-110) 0 V - 30,000 V (SMC IZD 10-510)	1,000 V
Zero point E-field sensor 1	Setting for compensation the zero point deviation 1	Super user (read, write)	-100 V - 100 V (SMC IZD 10-110) -1,000 V - 1,000 V (SMC IZD 10-510)	0 V
Sensor mode A2	Mode selection for the external sensor input A2	User (read) Super user (write)	OFF E-field-sensor	OFF
Type E-field sensor 2	Selection of the connected E-field sensors 2	User (read) Super user (write)	SMC IZD 10-110. SMC IZD 10-510	SMC IZD 10-110
Distance E-field sensor 2	Setting the distance for converting the E-field 2	User (read) Super user (write)	10 mm - 50 mm (SMC IZD 10-110) 25 mm - 75 mm (SMC IZD 10-510)	25 mm



Warning level E-field sensor 2	Setting for warning detection when measured value is exceeded 2	User (read) Super user (write)	0 V - 1,000 V (SMC IZD 10-110) 0 V - 30,000 V (SMC IZD 10-510)	800 V
Error level E-field sensor 2	Setting for error detection when measured value is exceeded 2	User (read) Super user (write)	0 V - 1,000 V (SMC IZD 10-110) 0 V - 30,000 V (SMC IZD 10-510)	1,000 V
Zero point E-field sensor 2	Setting for compen- sation the zero point deviation 2	Super user (read, write)	-100 V - 100 V (SMC IZD 10-110) -1,000 V - 1,000 V (SMC IZD 10-510)	0 V

A.4 Optimization of the residual charge

All power supply units of the ES61 series support a wide range of setting options for optimizing the residual charge measured on the surface of the substrate to be discharged. This measured value can be changed by setting the frequency or the voltage setpoint of the discharge voltage and the ion balance.

The setting of the individual parameters is not trivial and must be adjusted by the user for each application. Depending on the type of the device used and the working distance of the device, these settings can vary greatly.

The following information describes the procedure for setting the individual parameters. Recommendations for the individual parameters are also listed.

The first step is to optimize the ripple of the residual charge by adjusting the frequency of the discharge voltage. This ripple results from the AC high voltage generation. The set frequency of the discharge voltage corresponds to the measured frequency of the residual charge. By increasing the frequency, the ripple is reduced due to the increased change in polarity of the discharge voltage. After adjusting the frequency, the settings for the target value of the discharge voltage and the ion balance must now be used. As a rule, it is advisable to adjust the setpoint first and then the ion balance in a second step.

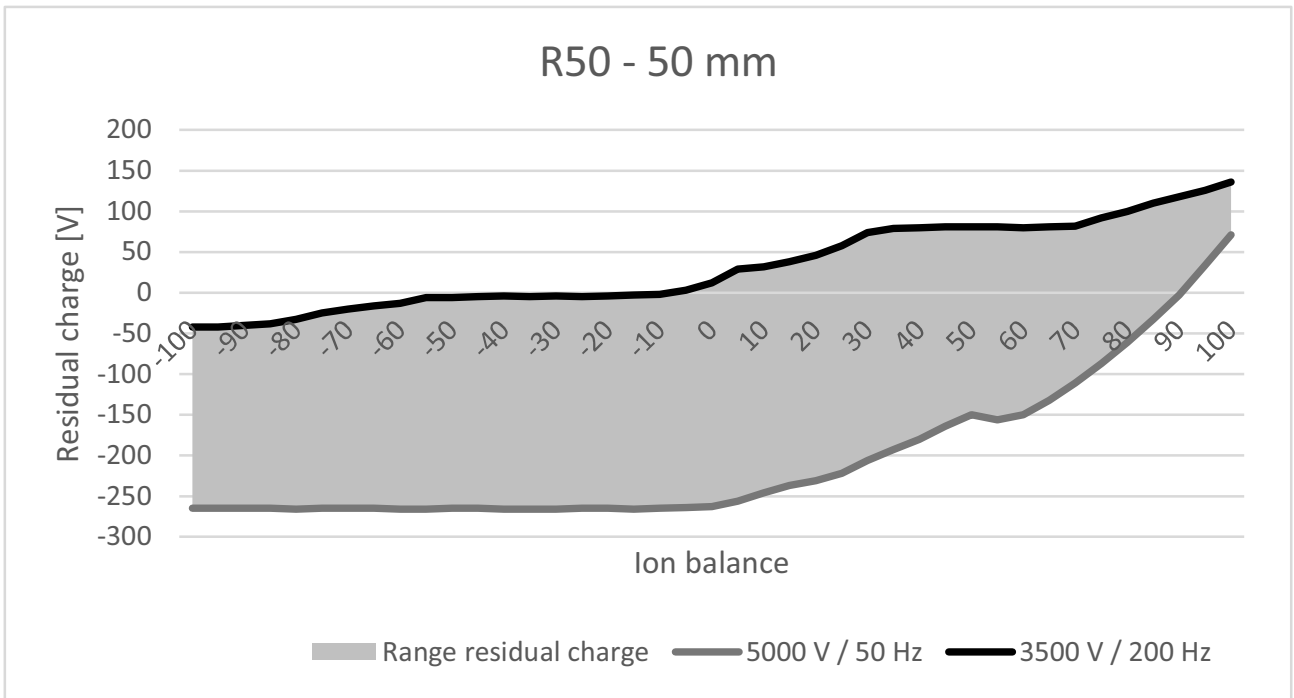

F00086v

Fig. 56:
Residual charge, discharging bar R50

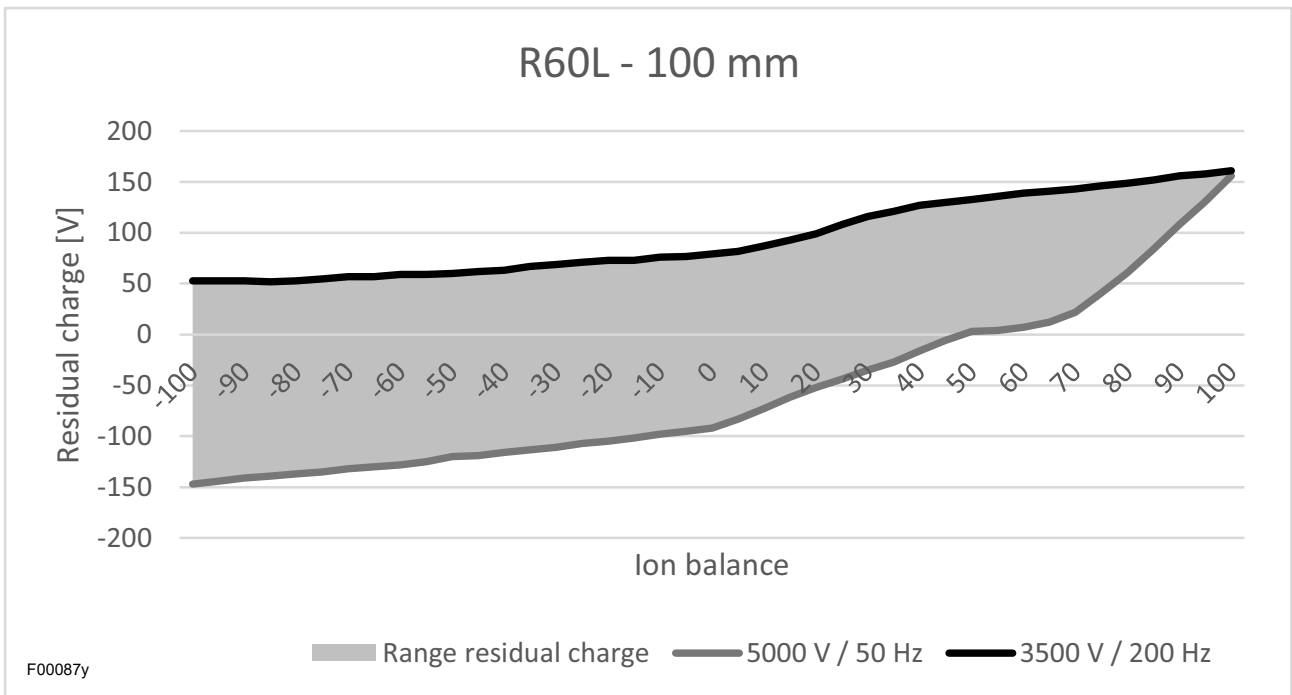

F00087y

Fig. 57:
Residual charge, discharging bar R60L

A.5 Pollution monitoring

Pollution monitoring is a component of the Performance Control integrated into the power supply unit for independent monitoring of the individual connections. Performance Control is only available in the ES61/P device variants and is an innovative principle for monitoring the connected devices.

R50, R60L, R47, R55E and PR55 series devices can be monitored for pollution of any kind.

The procedure for setting and using the pollution monitoring function is identical for all connections and devices.

- First, deactivate the discharge voltage before setting the parameters.
- In the next step, the values for the active length and cable length of the connected device must be set on the appliance.
For the R55E ion blower nozzles and PR55 ion blower pistols, the active length must be set to 15 mm.
- To ensure the best possible detection of pollution, always recalibrate the pollution monitoring system when replacing or reconnecting a device.
- Calibration takes place when the discharge voltage is activated. All necessary values for the connected device are determined and set during calibration.
After successful calibration, the pollution monitoring is active and monitors the connected devices.

Further settings for activating the reference point can be used to set the time or interval for carrying out pollution monitoring.

A fixed reference point is always used to set the discharge voltage for optimum assessment of the calculated values for the calibration data of the device.

The sensitivity for detecting the warning can be set individually for each connection using the warning level parameter.

The following is a schematic representation of the setting procedure.

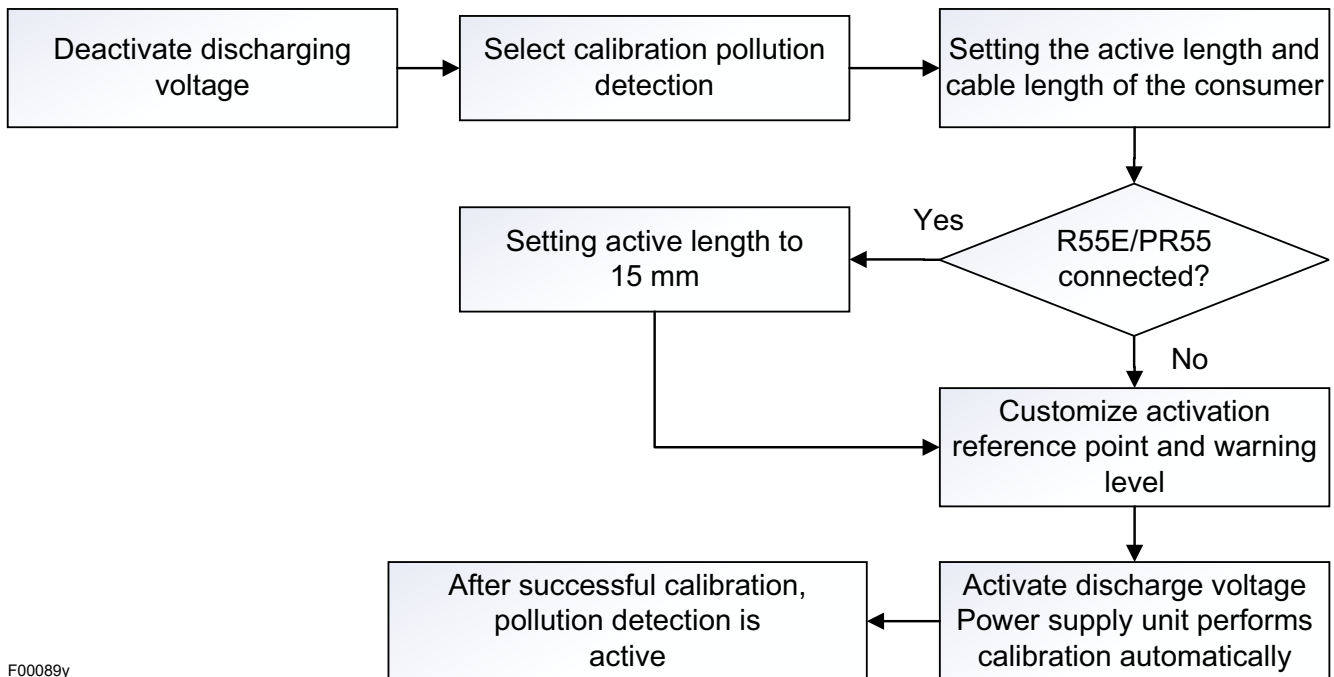

F00089y

*Fig. 58:
Procedure Setting pollution monitoring*

For more information on setting the pollution monitoring, see chapter 4.5.1.11 "Setup menu Performance Control", page 49 and chapter 4.5.2.5.2 "Performance Control Parameters", page 66.

EU-Declaration of Conformity

CE-2089-en-2405

Eltex-Elektrostatik-Gesellschaft mbH
Blauenstraße 67 - 69
D-79576 Weil am Rhein

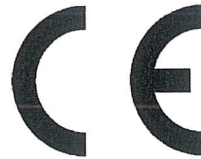

declares in its sole responsibility that the product

Power Supply Type **ES51, ES53, ES60, ES61** (according to Eltex reference code)

complies with the following directives and standards.

Relevant EU-Directive:

2014/35/EU

Low Voltage Directive

Harmonized standard applied:

EN 60204-1:2018

Safety of machinery – Electrical equipment of machines –
General requirements

Relevant EU-Directive:

2014/30/EU

EMC Directive

Harmonized standards applied:

EN 55011:2016 + A1:2017
+ A11:2020 + A2:2021

Industrial, scientific and medical equipment –
Radio-frequency disturbance characteristics – Limits and methods
of measurement

EN IEC 61000-3-2:2019

Electromagnetic compatibility (EMC) – Limits – Limit for harmonic
current emissions (equipment input current ≤ 16 A per phase)

EN 61000-3-3:2013 + A1:2019

Electromagnetic compatibility (EMC) – Limits – Limitation of voltage
changes, voltage fluctuations and flicker in public low-voltage supply
systems, for equipment with rated current ≤ 16 A per phase and not
subject to conditional connection

EN IEC 61000-6-2:2019

Electromagnetic compatibility (EMC) – Generic standards –
Immunity for industrial environments

Relevant EU-Directive:

2011/65/EU

RoHS Directive

in the version effective at the time of delivery.

Eltex-Elektrostatik-Gesellschaft mbH keep the following documents for inspection:

- proper operating instructions
- plans
- other technical documentation

Weil am Rhein, 14.05.2024
Place/Date



Lukas Hahne, Managing Director

UKCA Declaration of Conformity

CA-2089-en-2405

Eltex-Elektrostatik-Gesellschaft mbH
Blauenstraße 67 - 69
D-79576 Weil am Rhein



declares in its sole responsibility that the product

Power Supply Type ES51, ES53, ES60, ES61 (according to Eltex reference code)

complies with the following directives and standards.

Applicable Regulation:

S.I. 2016 No. 1101

Electrical Equipment (Safety) Regulations

Used Designated Standard:

BS EN 60204-1:2018

Applicable Regulation:

S.I. 2016 No. 1091

Electromagnetic Compatibility Regulations

Used Designated Standard:

BS EN IEC 61000-3-2:2019+A1:2021

BS EN 61000-3-3:2013+A2:2021

BS EN IEC 61000-6-2:2019

BS EN 55011:2016+A2:2021

Applicable Regulation:

S.I. 2012 No. 3032

RoHS Regulations

in the version effective at the time of delivery.

Eltex-Elektrostatik-Gesellschaft mbH keep the following documents for inspection:

- proper operating instructions
- plans
- other technical documentation

Weil am Rhein, 14.05.2024
Place/Date



Lukas Hahne, Managing Director

Eltex offices and agencies

The addresses of all
Eltex agencies can be
found on our website at
www.eltex.de



z01007y



Eltex-Elektrostatik-Gesellschaft mbH
Blauenstraße 67-69
79576 Weil am Rhein | Germany
Phone +49 (0) 7621 7905-422
eMail info@eltex.de
Internet www.eltex.de